



Zastosowanie

Wentylacja ogólna pomieszczeń o charakterze użytkowym i przemysłowym. Przeznaczone do wentylacji: hurtowni, magazynów, warsztatów, hal produkcyjnych, parkingów, lokali handlowych, szklarni, pomieszczeń hodowlanych (kurniki, chlewnie). Znajdują zastosowanie w urządzeniach klimatyzacyjnych.

Konstrukcja

Wentylatory osiowe o unikalnej, bardzo zwartej konstrukcji przystosowane do montażu ściennego w dowolnej pozycji. Wirniki z odpornego na działanie promieni UV termoplastu wzmocnionego włóknem szklanym (HCFT/HCFB) lub aluminiowe (HCBT/HCBB), dynamicznie wyważane zgodnie z normą ISO 1940. Obudowa wytłaczana z blachy stalowej, pokryta czarną farbą epoksydową. Wentylatory mogą pracować w temperaturze -40°C +70°C (modele 800-1000 zakres -20°C +40°C).

Silnik elektryczny

Asynchroniczny, trójfazowy 220-240/380-415V 50 Hz lub jednofazowy 220-240V 50 Hz, wykonany zgodnie ze standardami UNE-113, IEC 34-1. Stopień ochrony IP65 (modele 800,900,1000 - IP55), klasa izolacji F. Silnik przystosowany jest do pracy w atmosferze o wilgotności względnej do 95%. Silnik posiada termiczne zabezpieczenie uzwojenia przed przeciążeniem (nie dotyczy modeli dwubiegunowych oraz 800, 900 i 1000) i standardowo przystosowany jest do napięciowej regulacji prędkości obrotowej (nie dotyczy silników dwubiegunowych oraz 4-630, 710 (FB, FT, BB) oraz BT/4-710, 800 (BT i FT), 900 (BT i FT), 1000 (BT i FT)). Modele trójfazowe są przystosowane do regulacji przetwornicą częstotliwości.

Schemat podłączenia elektrycznego dla silników jednofazowych:

w modelach 250-400: rys. 4 str. 925,

• w modelach 450-710: rys. 5 str. 925.

Schemat podłączenia elektrycznego dla silników trójfazowych: rys. 6 str. 925.

Wersje EX znajdują się w rozdziale z wentylatorami przeciwwybuchowymi.

Modele 800, 900, 1000 - nie są standardowo wyposażone w siatkę zabezpieczającą - siatka dostępna na zamówienie.

Oznaczenia

HCFT/4-400/HA □

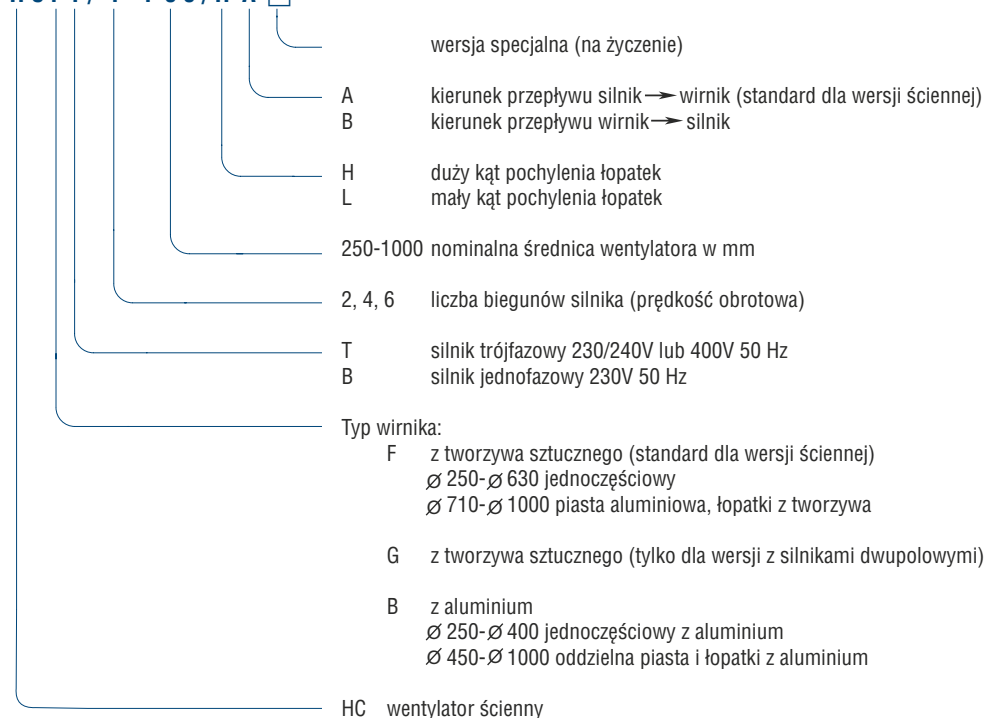

Akcesoria



żaluzje
PER-W
str. 207



żaluzje
PER-CN
str. 208



regulator
REB
str. 892



regulator
RMB, RMT
str. 892



REB 4 - Auto
str. 893

Dane techniczne wentylatorów HCFT/HCFB (wirnik z tworzywa)

ilość biegunów	Typ ściennie	prędkość obrotowa [obr./min]	pobór mocy max. [W]	natężenie		poziom ciśnienia akustycznego [dB(A)**	wydajność max. [m³/h]	regulator*	masa [kg]	nr artykułu			
				230V [A]	400V [A]								
JEDNOFAZOWE													
NOWOŚĆ	2	HCGB/2-315/I	2690	374	1,6	-	63	3240	-	7	-		
		HCGB/2-355/I	2720	383	1,6	-	68	3550	-	8	-		
4	4	HCFB/4-250/H	1380	77	0,3	-	49	1090	REB-1/RMB-1,5	5	41520020		
		HCFB/4-315/H	1340	125	0,6	-	55	2220	REB-1/RMB-1,5	7	41520060		
		HCFB/4-355/H	1415	168	0,8	-	59	3450	REB-2,5/RMB-1,5	8	41520100		
		HCFB/4-400/H	1420	271	1,2	-	62	4890	REB-2,5/RMB-3,5	9	41520140		
		HCFB/4-450/H	1380	463	1,9	-	65	6650	REB-2,5/RMB-3,5	13	41520180		
		HCFB/4-500/H	1400	675	2,9	-	68	8810	REB-5/RMB-3,5	16	41520220		
		HCFB/4-560/H	1410	1102	4,7	-	70	12980	REB-5/RMB-8	22	41520260		
		HCFB/4-630/H	1380	1573	7,1	-	73	17230	-	25	41520300		
6	6	HCFB/6-315/H	990	80	0,4	-	45	1560	REB-1/RMB-1,5	7	-		
		HCFB/6-355/H	920	81	0,4	-	48	2250	REB-1/RMB-1,5	8	41520480		
		HCFB/6-400/H	885	100	0,4	-	51	2980	REB-1/RMB-1,5	9	41520520		
		HCFB/6-450/H	895	164	0,7	-	54	4390	REB-2,5/RMB-1,5	13	41520560		
		HCFB/6-500/H	905	219	1	-	57	5820	REB-2,5/RMB-3,5	16	41520600		
		HCFB/6-560/H	905	321	1,3	-	59	8120	REB-2,5/RMB-3,5	22	41520640		
NOWOŚĆ	2	TRÓJFAZOWE											
		HCFT/2-315/L	2660	437	2,3	1,3	68	3650	-	7	-		
4	4	HCFT/4-250/H	1365	73	0,3	0,2	49	1110	RMT-1,5	5	41520010		
		HCFT/4-315/H	1340	124	0,5	0,3	55	2170	RMT-1,5	7	41520050		
		HCFT/4-355/H	1380	164	1,4	0,8	59	3370	RMT-1,5	8	41520090		
		HCFT/4-400/H	1370	250	1,7	1	62	4740	RMT-1,5	9	41520130		
		HCFT/4-450/H	1380	449	2,6	1,5	65	6640	RMT-1,5	13	41520170		
		HCFT/4-500/H	1460	767	3,5	2	68	9750	RMT-2,5	16	41520210		
		HCFT/4-560/H	1405	1051	3,7	2,1	70	12280	RMT-2,5	22	41520250		
		HCFT/4-630/H	1425	1582	5	2,9	73	17900	-	25	41520290		
		HCFT/4-710/H	1375	2413	7,4	4,3	74	22140	-	27	41523350		
		HCFT/4-800/L-X(1,5kW)	1420	2308	6,6	3,8	78	22750	-	37	42020010		
		HCFT/4-800/H-X(3kW)	1450	4344	12,5	7,2	84	33410	-	52	42020020		
		HCFT/4-900/L-X(3kW)	1460	3845	11,3	6,5	82	25550	-	94	42020026		
		HCFT/4-900/H-X(5,5kW)	1460	7090	-	12,3	87	45550	-	110	42020028		
		HCFT/4-1000/L-X(3kW)	1440	5098	14,2	8,2	86	38800	-	67	42020070		
		HCFT/4-1000/H-X(5,5kW)	1450	8053	-	13,5	93	47380	-	95	42020075		
		6	6	HCFT/6-355/H	925	83	0,3	0,2	48	2260	RMT-1,5	8	41520470
				HCFT/6-400/H	880	107	0,5	0,3	51	3070	RMT-1,5	9	41520510
				HCFT/6-450/H	945	179	0,9	0,5	54	4530	RMT-1,5	13	41520550
HCFT/6-500/H	920			232	1	0,6	57	6060	RMT-1,5	16	41520590		
HCFT/6-560/H	925			337	1,2	0,7	59	8320	RMT-1,5	22	41520630		
HCFT/6-630/H	920			534	2,1	1,2	62	11400	RMT-1,5	25	41520670		
HCFT/6-710/G	955			888	4,5	2,6	65	16160	RMT-5	27	41520715		
HCFT/6-800/L-X(0,55kW)	940			1042	3,5	2	73	18310	-	31	42020030		
HCFT/6-800/H-X(0,75kW)	945			1160	3,8	2,2	75	19960	-	36	42020040		
HCFT/6-900/L-X(1,1kW)	965			1266	4,7	2,7	74	23160	-	86	42020044		
HCFT/6-900/H-X(1,5kW)	955			2202	7,1	4,1	78	31720	-	93	42020048		
HCFT/6-1000/L-X(1,1kW)	940			1749	5,7	3,3	79	28970	-	54	42020080		
HCFT/6-1000/H-X(1,5kW)	945	2627	8,1	4,7	84	37980	-	62	42020090				

* - regulatory obrotów nie są sprzedawane w komplecie z wentylatorem. Wentylatory, przy których nie zaznaczono regulatorów, nie są przystosowane do regulacji prędkości obrotowej. Wentylatory z napięciem 400V są przystosowane do regulacji napięciowej w zakresie 25 - 50 Hz.

** - poziom ciśnienia akustycznego mierzony z odległości 3 średnic od wentylatora, jednak nie mniej niż 1,5m (pomiar w wolnej przestrzeni, bez kanałów przyłączeniowych).

Dane techniczne wentylatorów HCBT/HCBB (wirnik aluminiowy)

ilość biegunów	Typ ścienne	prędkość obrotowa [obr./min]	pobór mocy max. [W]	natężenie		poziom ciśnienia akustycznego [dB(A)]**	wydajność max. [m³/h]	regulator*	masa [kg]	nr artykułu	
				230V [A]	400V [A]						
JEDNOFAZOWE											
4	HCBB/4-250/H	1325	84	0,4	-	49	1130	REB-1/RMB-1,5	5	41520025	
	HCBB/4-315/H	1295	140	0,7	-	55	2310	REB-1/RMB-1,5	7	41520065	
	HCBB/4-355/H	1385	193	0,9	-	59	3560	REB-2,5/RMB-1,5	8	41520105	
	HCBB/4-400/H	1360	315	1,5	-	62	4830	REB-2,5/RMB-3,5	9	41520145	
	HCBB/4-450/H	1410	626	2,8	-	65	7180	REB-2,5/RMB-3,5	13	41520185	
	HCBB/4-500/H	1365	787	3,4	-	68	8810	REB-5/RMB-3,5	16	41520225	
	HCBB/4-560/H	1370	1266	5,7	-	70	12580	REB-10/RMB-8	22	41520265	
	HCBB/4-630/H	1360	1879	8,3	-	71	16550	-	25	41520305	
6	HCBB/6-355/H	910	84	0,4	-	48	2230	REB-1/RMB-1,5	8	41520485	
	HCBB/6-400/H	845	112	0,5	-	51	3010	REB-1/RMB-1,5	9	41520525	
	HCBB/6-450/H	880	178	0,8	-	54	4400	REB-2,5/RMB-1,5	13	41520565	
	HCBB/6-500/H	910	276	1,2	-	57	5900	REB-2,5/RMB-3,5	16	41520605	
	HCBB/6-560/H	905	456	1,9	-	59	8880	REB-2,5/RMB-3,5	22	41520645	
	HCBB/6-630/H	910	614	3	-	62	10580	REB-5/RMB-3,5	25	41520685	
TRÓJFAZOWE											
4	HCBT/4-250/H	1330	81	0,3	0,2	49	1120	RMT-1,5	5	41520016	
	HCBT/4-315/H	1320	162	0,7	0,4	55	2370	RMT-1,5	7	41520055	
	HCBT/4-355/H	1370	182	0,8	0,5	59	3480	RMT-1,5	8	41520095	
	HCBT/4-400/H	1320	288	1,1	0,6	62	4880	RMT-1,5	9	41520131	
	HCBT/4-450/H	1350	511	1,6	0,9	65	6310	RMT-1,5	13	41520171	
	HCBT/4-500/H	1390	809	2,7	1,6	68	9030	RMT-2,5	16	41520215	
	HCBT/4-560/H	1390	1287	4	2,3	70	12760	RMT-2,5	22	41520251	
	HCBT/4-630/H	1385	1736	5,4	3,1	73	16840	-	25	41520291	
	HCBT/4-710/H	1350	2554	7,6	4,4	74	22330	-	27	41529330	
	HCBT/4-800/L-X(1,5kW)	1410	2632	7,3	4,2	78	23290	-	37	42020055	
	HCBT/4-800/H-X(3kW)	1440	4595	12,8	7,4	84	33100	-	52	42929965	
	HCBT/4-900/L-X(3kW)	1450	3909	12	6,9	82	34270	-	96	42020026	
	HCBT/4-900/H-X(5,5kW)	1455	7893	-	13,4	87	46270	-	112	42020028	
	HCBT/4-1000/L-X(3kW)	1415	5048	14,2	8,2	86	39910	-	67	42020072	
	HCBT/4-1000/H-X(5,5kW)	1440	9227	-	15,1	93	49200	-	95	42020077	
	6	HCBT/6-355/H	900	91	0,3	0,2	48	2270	RMT-1,5	8	41520475
		HCBT/6-400/H	840	120	0,5	0,3	51	3050	RMT-1,5	9	41520515
		HCBT/6-450/H	945	184	0,9	0,5	54	4490	RMT-1,5	13	41520555
HCBT/6-500/H		910	261	0,5	0,3	57	6060	RMT-1,5	16	41520595	
HCBT/6-560/H		895	421	1,4	0,8	59	8650	RMT-1,5	22	41520635	
HCBT/6-630/H		910	596	2,3	1,3	62	10950	RMT-1,5	25	41520675	
HCBT/6-710/H		950	953	4,7	2,7	65	15330	RMT-5	27	41520710	
HCBT/6-800/L-X(0,75kW)		940	1025	3,3	1,9	73	17600	-	31	42020035	
HCBT/6-800/H-X(0,75kW)		935	1309	4,2	2,4	75	20590	-	36	42929945	
HCBT/6-900/L-X(1,1kW)		960	1341	4,8	2,8	74	23700	-	88	42020044	
HCBT/6-900/H-X(1,5kW)		955	2289	7,3	4,2	78	32300	-	95	42020048	
HCBT/6-1000/L-X(1,1kW)		940	1855	5,9	3,4	79	28810	-	54	42020085	
HCBT/6-1000/H-X(1,5kW)	940	2795	8,5	4,9	84	37710	-	62	42020095		

* - regulatory obrotów nie są sprzedawane w komplecie z wentylatorem. Wentylatory, przy których nie zaznaczono regulatorów, nie są przystosowane do regulacji prędkości obrotowej. Wentylatory z napięciem 400V są przystosowane do regulacji napięciowej w zakresie 25 - 50 Hz.

** - poziomy ciśnienia akustycznego mierzony z odległości 3 średnic od wentylatora, jednak nie mniej niż 1,5m (pomiar w wolnej przestrzeni, bez kanałów przyłączeniowych).

Wymiary [mm]

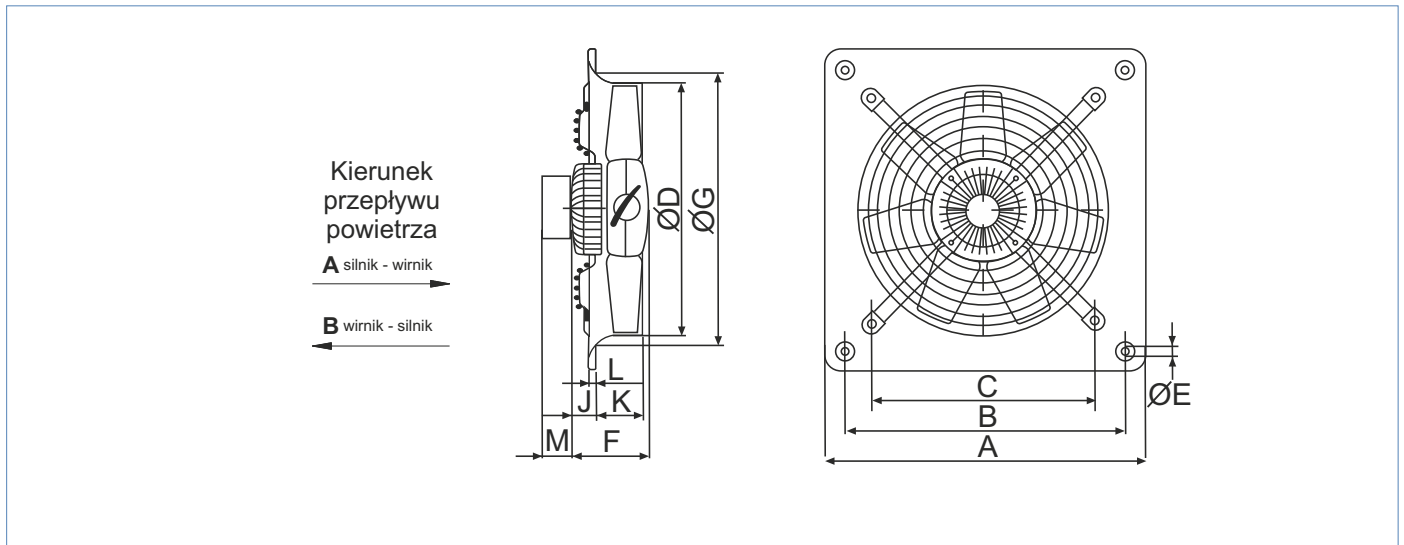

Typ	A	B	C	ØD	ØE	/2			ØG	/2			K	L	M	
						/4	/6			/4	/6	HCFT			HCFB	
250	315	260	220	254	10		122		294		59		53	12	40	65
315	400	330	280	315	10	129	122	122	329	45	32	32	68	12	40	65
355	450	380	315	355	10	129	129	129	371	45	45	45	75	12	40	65
400	500	420	355	400	10		129	129	422		40,5	40,5	78	12	40	65
450	560	480	400	450	10		150	150	476		48	48	91	12	40	65
500	630	560	450	500	10		150	150	536		44,5	44,5	97	12	40	65
560	710	630	510	560	10		218,5	150	596		110,5	42	98,5	12	40	65
630	800	710	580	630	12		218,5	150	674		110,5	41	103	12	40	65
710	900	800	636	710	12		218,5	218,5	733		134	134	91,5	16,5	40	65

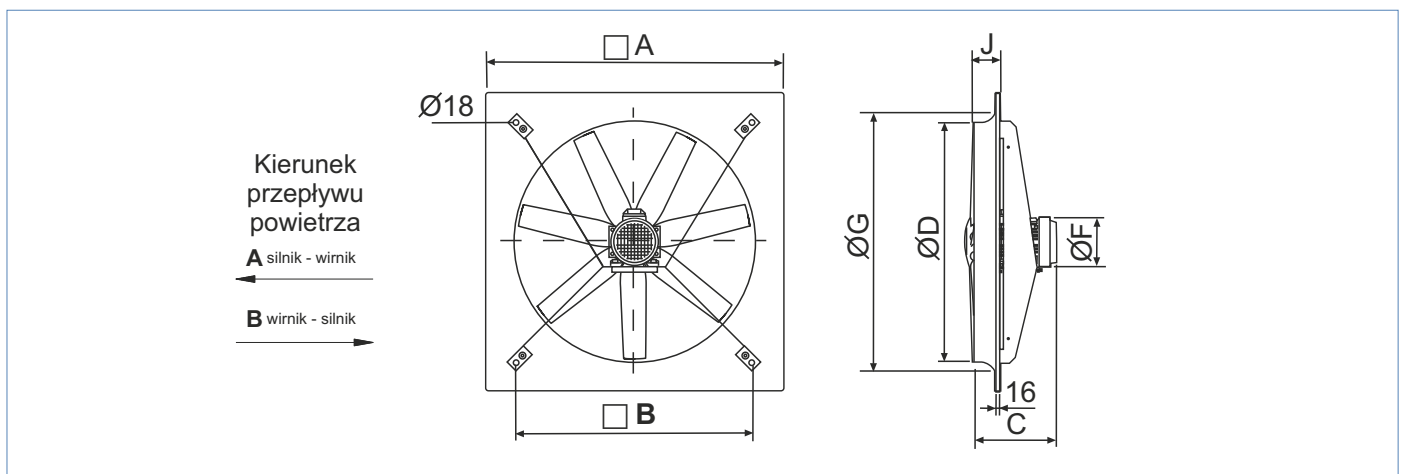

Typ	□A	□B	ØD	J	ØG	C				ØF										
						L	/4	H		L	/6	H		L	/4	H	L	/6	H	
800	1000	800	800	92	926	345		380		310		345		181		203		162		181
900	1120	900	900	120	1060	392		439		350		392		203		280		181		203
1000	1250	1000	1000	110	1154	380		380		345		380		203		280		181		203

* kąt nachylenia łopatek: L - mały, H - duży.
 * X - bez osłony wlotu

Charakterystyka akustyczna

Poziom mocy akustycznej dla poszczególnych częstotliwości.

Typ	63	125	250	500	1000	2000	4000	8000	LwA
2-BIEGUNOWE									
HCGB/2-315	50	61	68	70	72	69	64	58	77
HCGT/2-315	55	66	73	75	77	74	69	63	82
HCGB/2-355	55	66	73	75	77	74	69	63	82
HCGT/2-355	55	70	69	77	82	78	73	66	85
4-BIEGUNOWE									
/4-250/H	31	45	52	57	58	57	52	44	63
/4-315/H	42	53	60	62	64	61	56	50	69
/4-355/H	43	58	57	65	70	66	61	54	73
/4-400/H	48	61	62	68	73	69	66	57	76
/4-450/H	46	65	62	68	75	74	69	62	79
/4-500/H	49	68	68	74	78	76	72	65	82
/4-560/H	57	70	74	78	80	78	74	67	85
/4-630/H	57	72	76	81	85	82	79	72	89

Typ	63	125	250	500	1000	2000	4000	8000	LwA
4-BIEGUNOWE									
/4-710/H	58	75	83	85	87	85	81	72	92
/4-800/L	58	77	87	93	93	89	83	76	97
/4-800/H	64	83	93	99	99	95	89	82	103
/4-900/L	59	81	91	97	98	94	88	80	102
/4-900/H	64	86	96	102	103	99	93	85	107
/4-1000/L	62	85	95	101	102	98	93	84	106
/4-1000/H	69	92	102	107	109	105	100	90	113
6-BIEGUNOWE									
/6-315/H	32	43	50	52	54	51	46	40	59
/6-355/H	32	47	46	54	59	55	50	43	62
/6-400/H	37	50	51	57	62	58	55	46	65
/6-450/H	35	54	51	57	64	63	58	51	68
/6-500/H	38	57	57	63	67	65	61	54	71
/6-560/H	46	59	63	67	69	67	63	56	74
/6-630/H	46	61	65	70	74	71	68	61	78
/6-710/H	49	66	74	76	78	76	72	63	83
/6-800/L	52	71	81	87	87	83	77	70	91
/6-800/H	54	73	83	89	89	85	79	72	93
/6-900/L	51	73	83	89	90	86	80	72	94
/6-900/H	55	77	87	93	94	90	84	76	98
/6-1000/L	56	78	89	94	96	92	86	77	100
/6-1000/H	60	83	93	99	100	96	91	82	104

Charakterystyki pracy

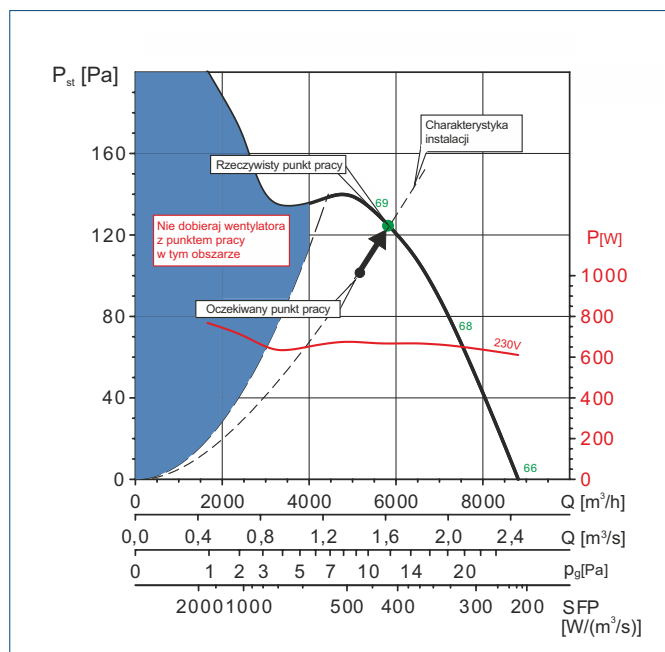

ZASADY DOBORU WENTYLATORA:

- Nie wybieraj punktu pracy w obszarze wykresu zaznaczonego kolorem.
- Do znalezienia rzeczywistego punktu pracy wentylatora niezbędne jest wyznaczenie charakterystyki układu wentylacji.
- Punkt pracy powinien znajdować się możliwie najbliżej linii wykresu charakterystyki wentylatora.

PRZYKŁADOWY DOBÓR:

- Oczekiwany punkt pracy: 102 Pa i 5150 m³/h
- Rzeczywisty punkt pracy odczytany z wykresu: 124 Pa i 5800 m³/h

Q - wydajność [m³/h], [m³/s],
 P_{st} - ciśnienie statyczne [Pa],
 p_0 - opory na siatce zabezpieczającej [Pa],
 SFP - moc właściwa wentylatora [W/(m³/s)]

Charakterystyki pracy

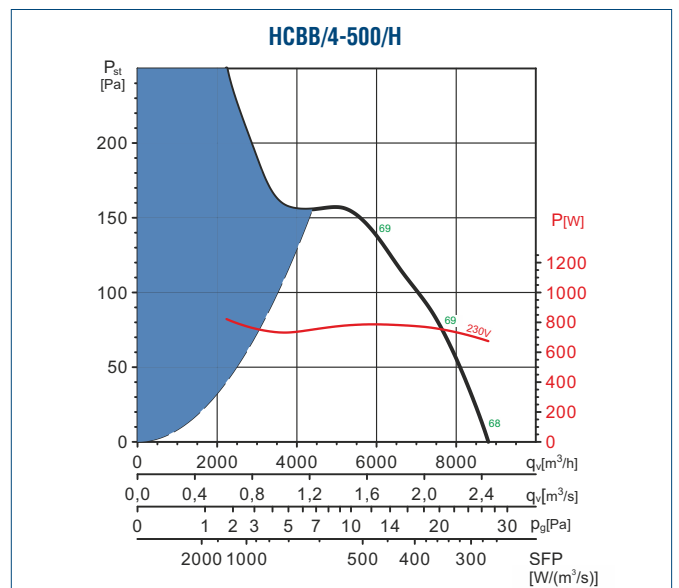
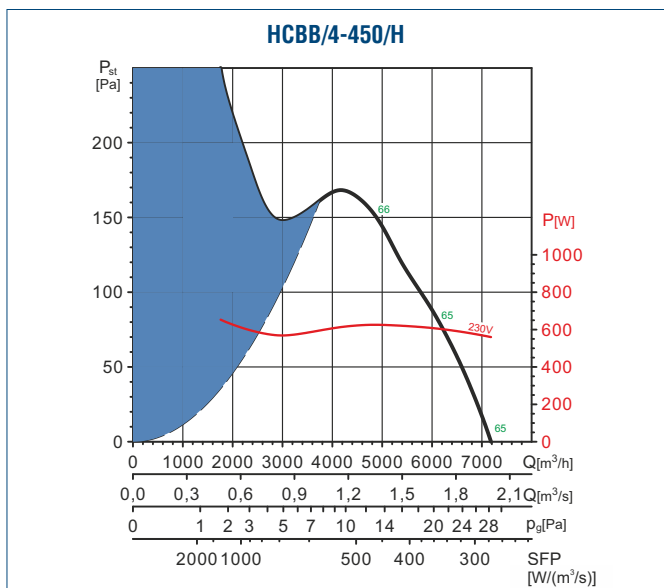
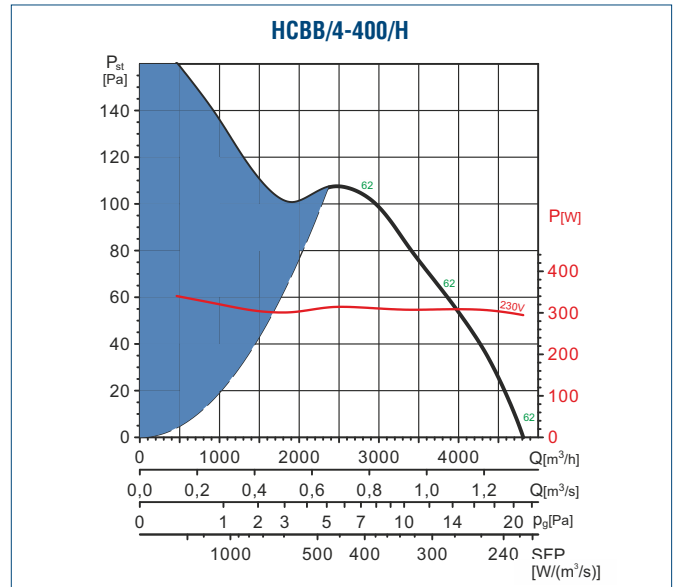
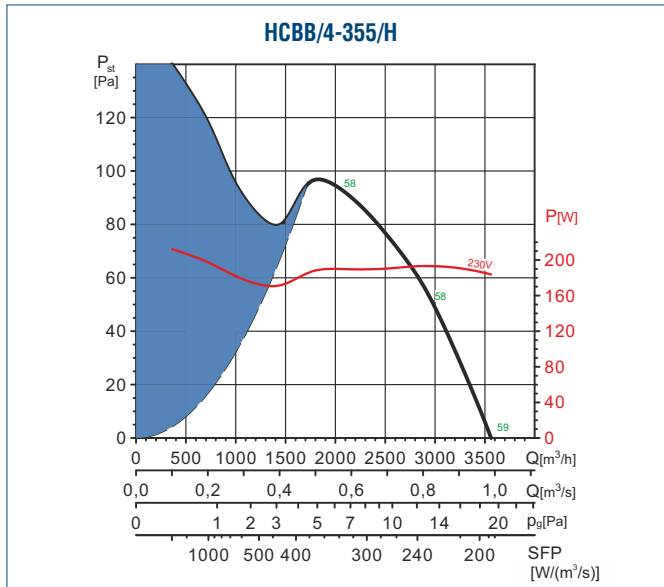
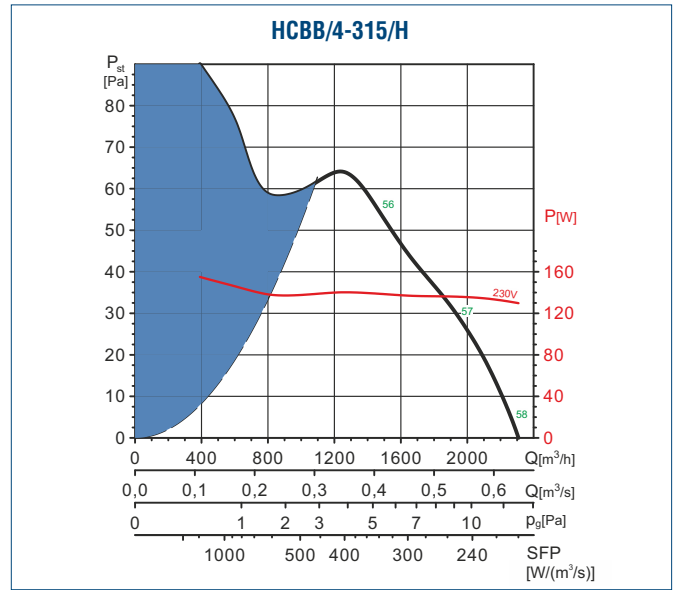
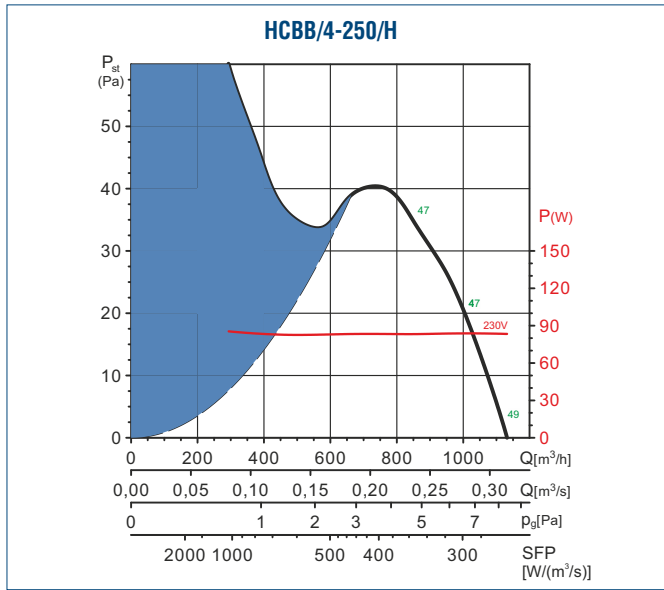

Charakterystyki pracy

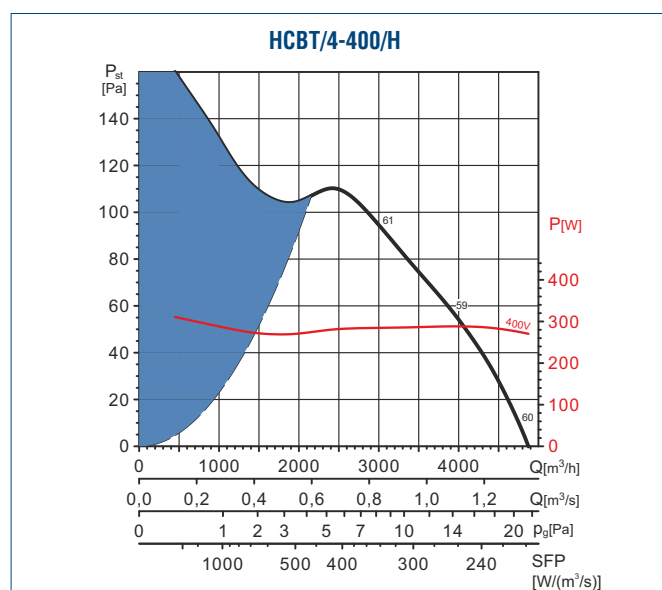
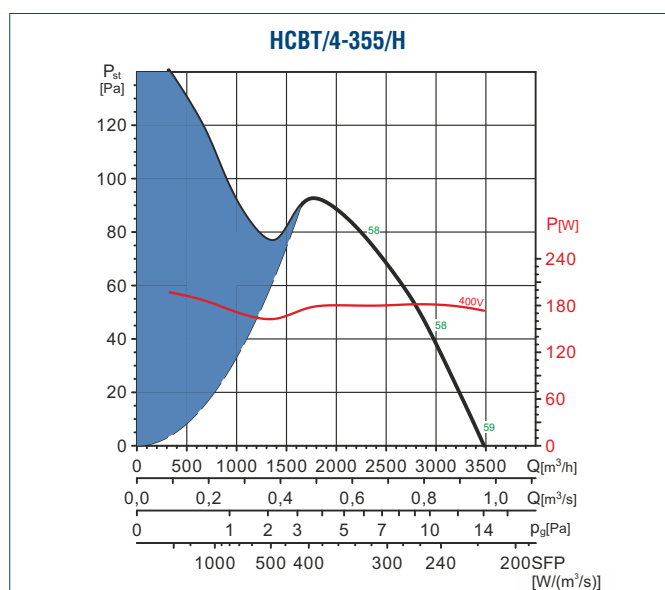
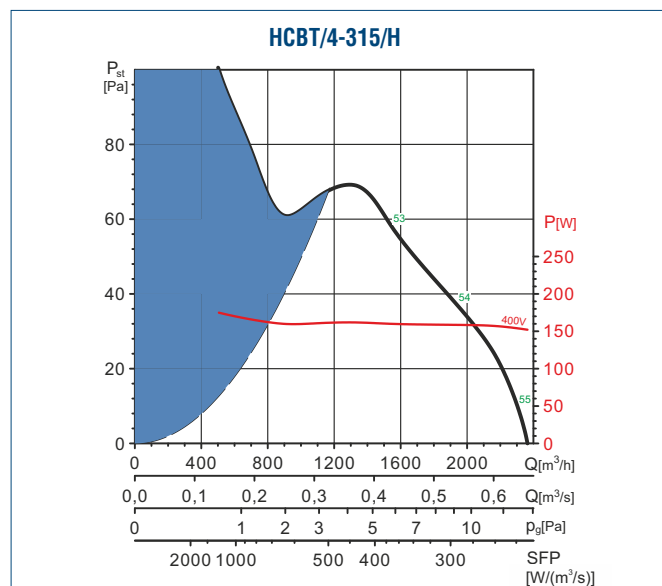
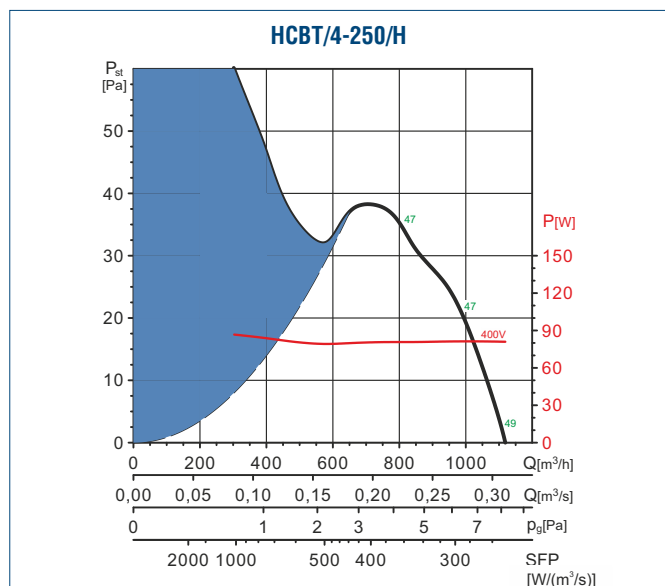
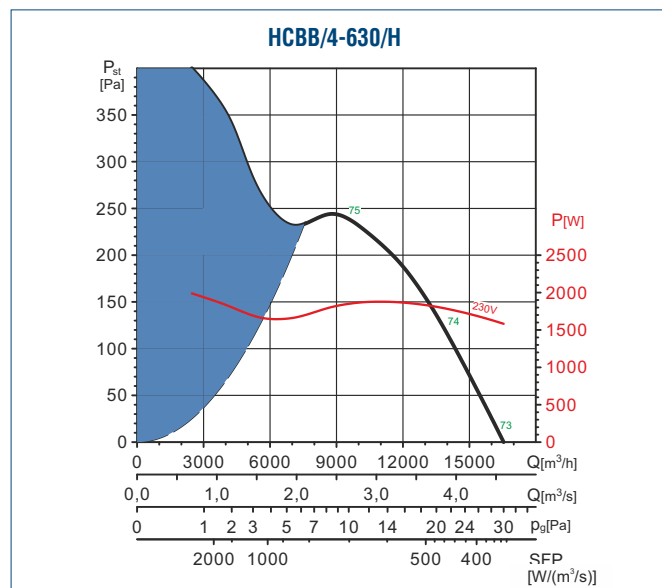
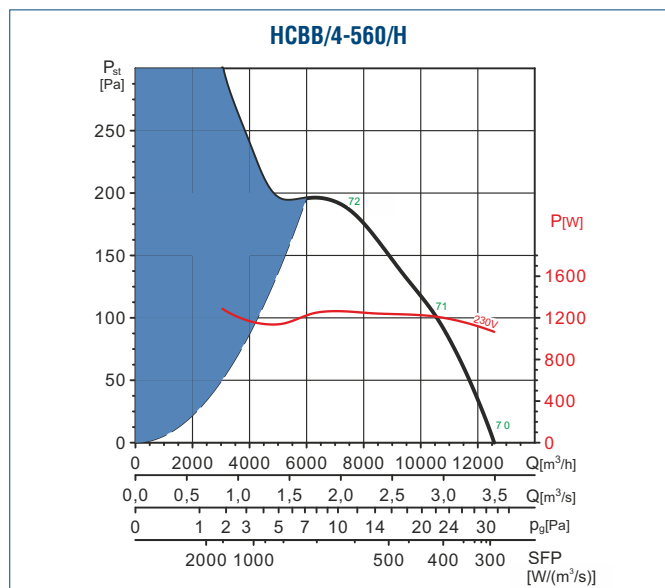

Charakterystyki pracy

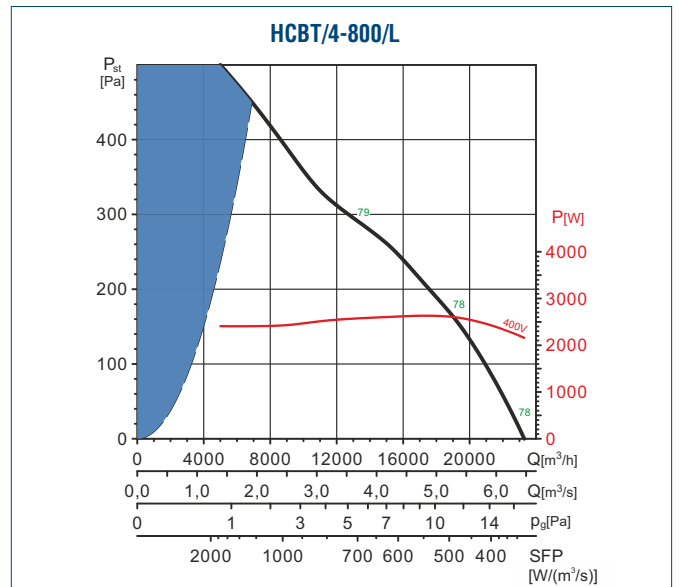
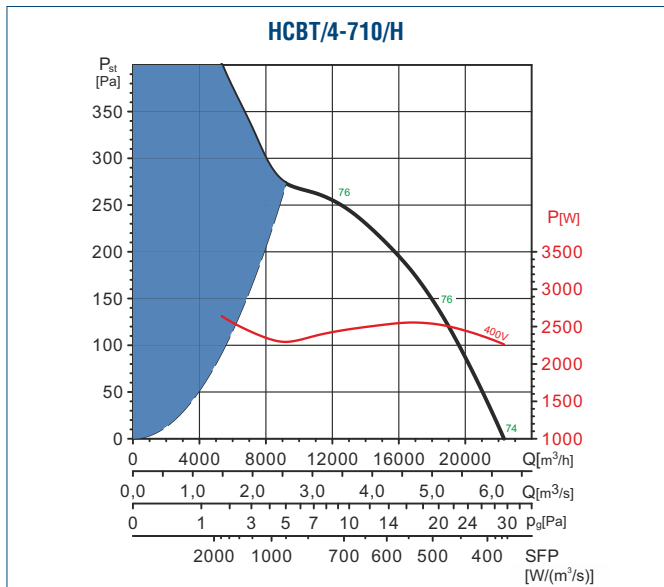
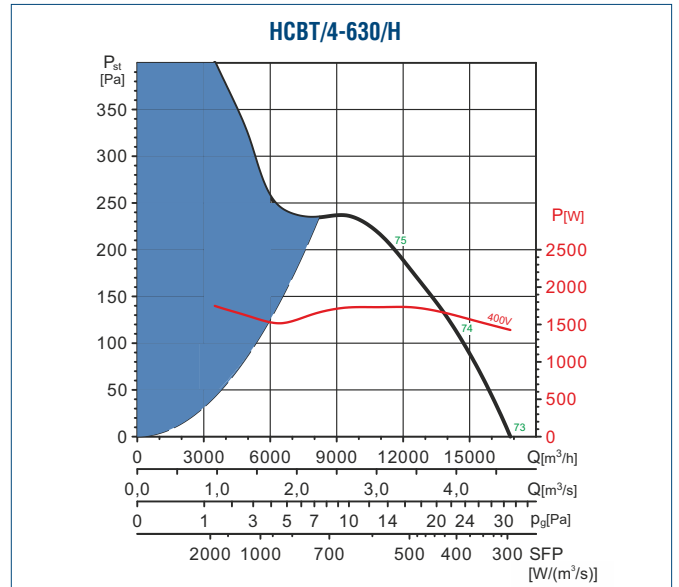
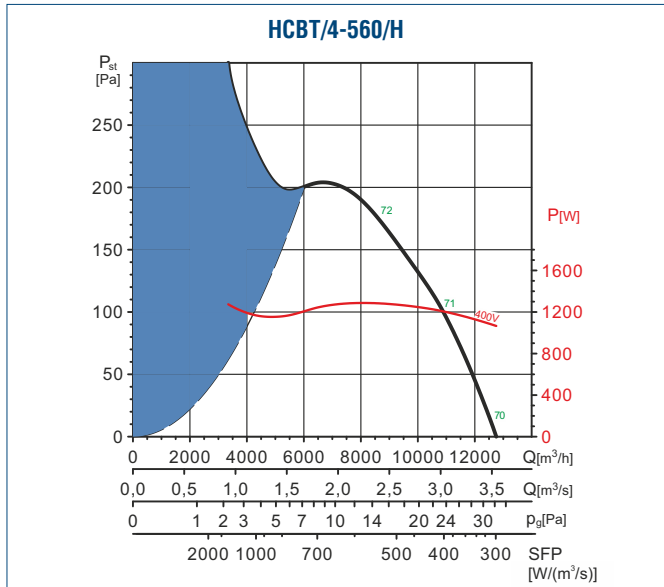
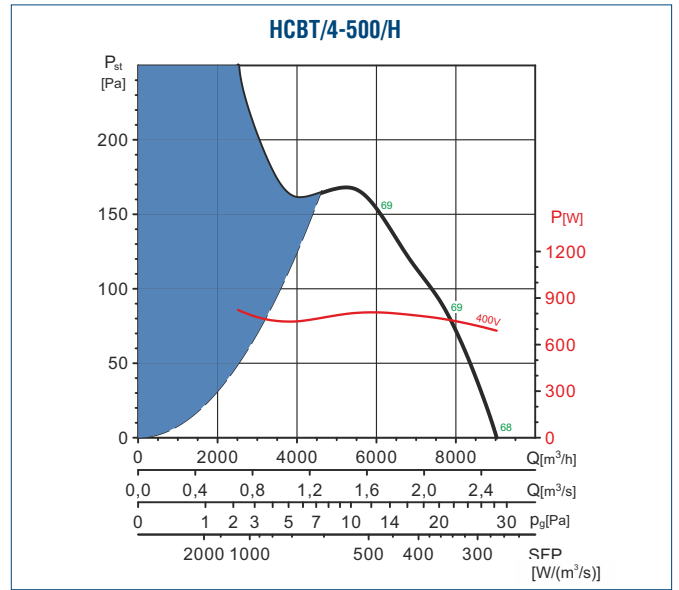
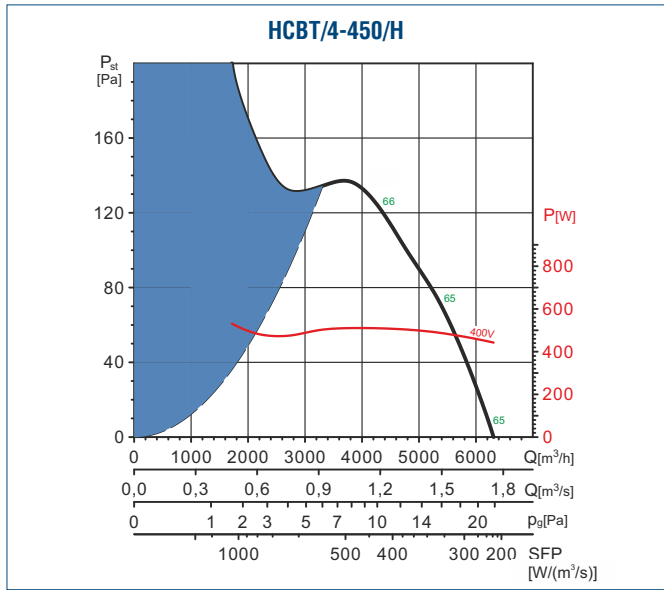

Charakterystyki pracy

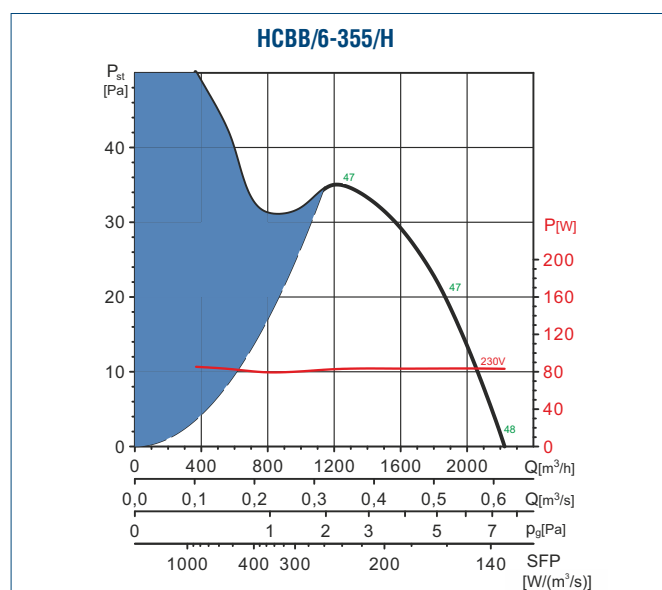
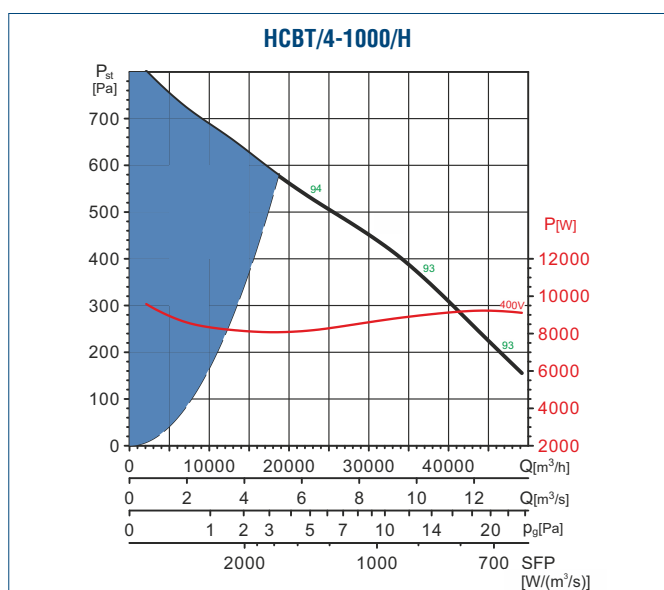
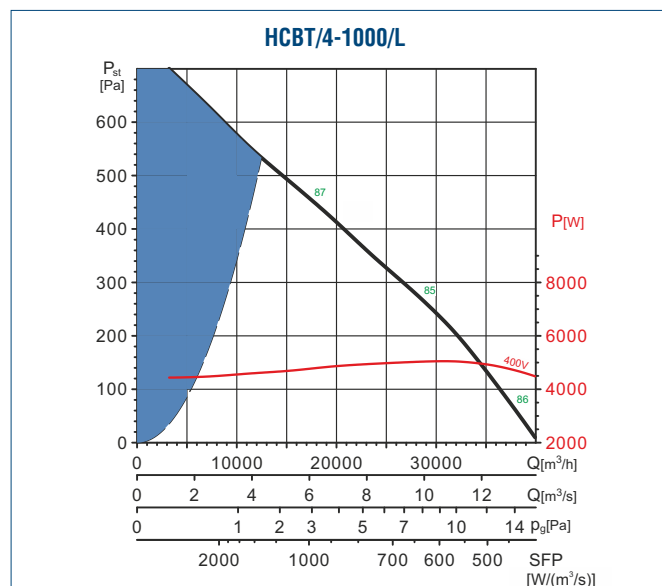
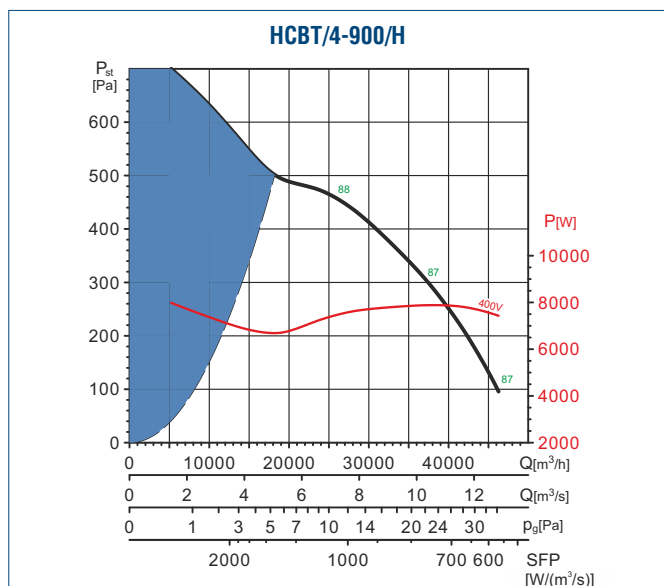
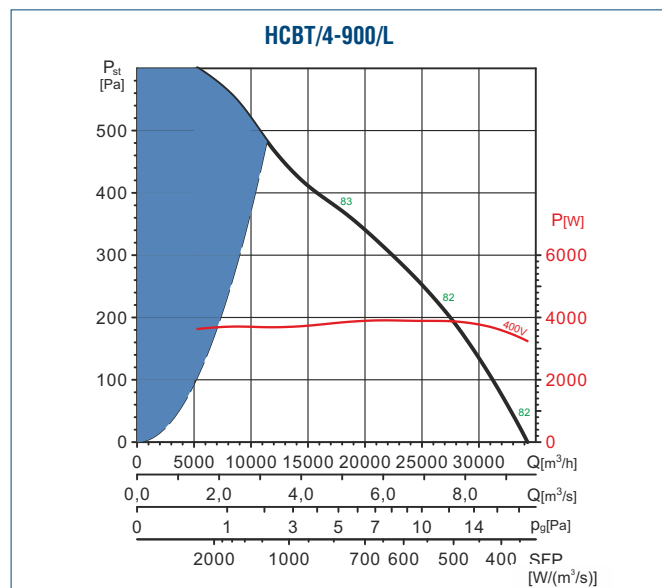
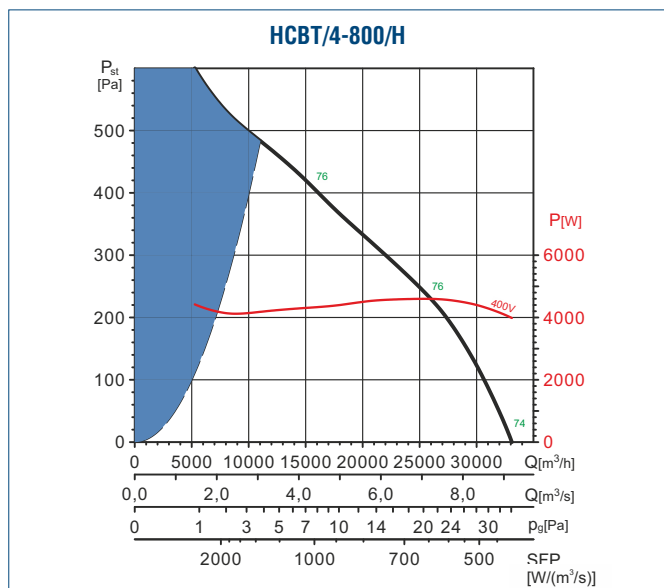

Charakterystyki pracy

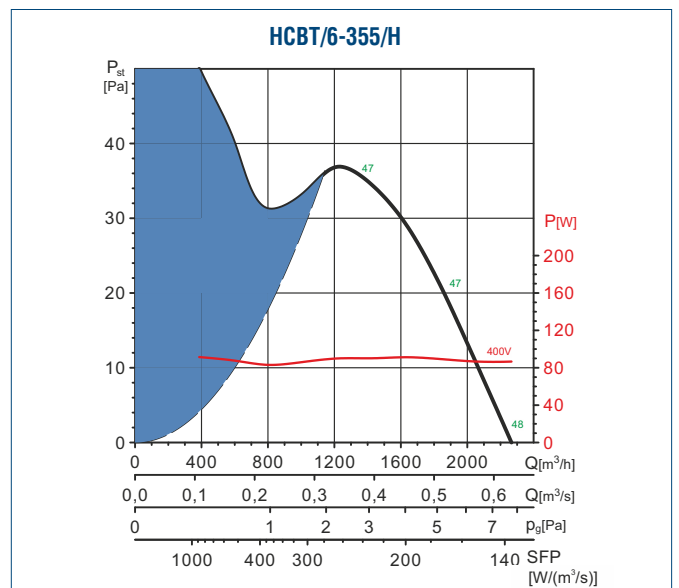
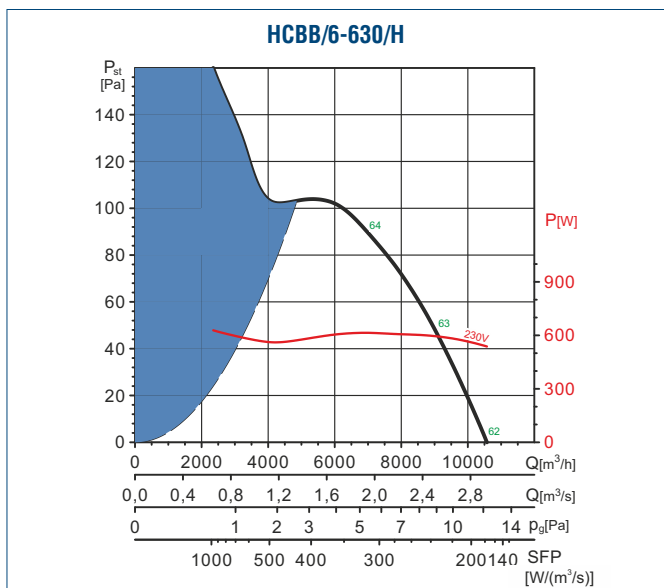
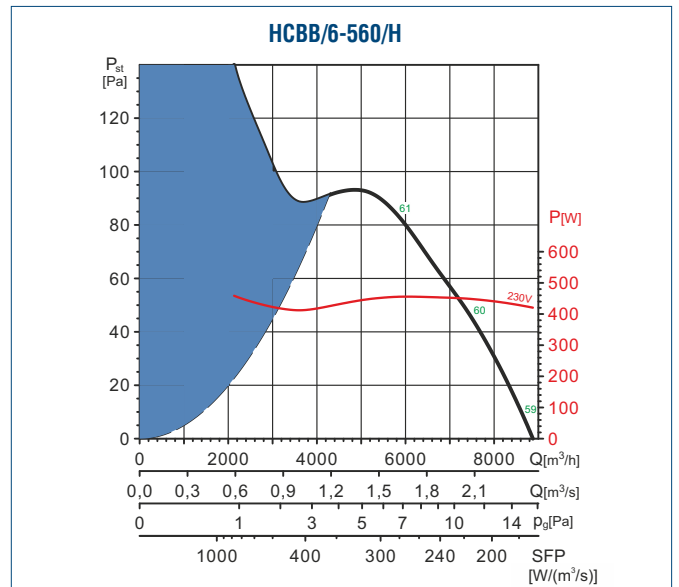
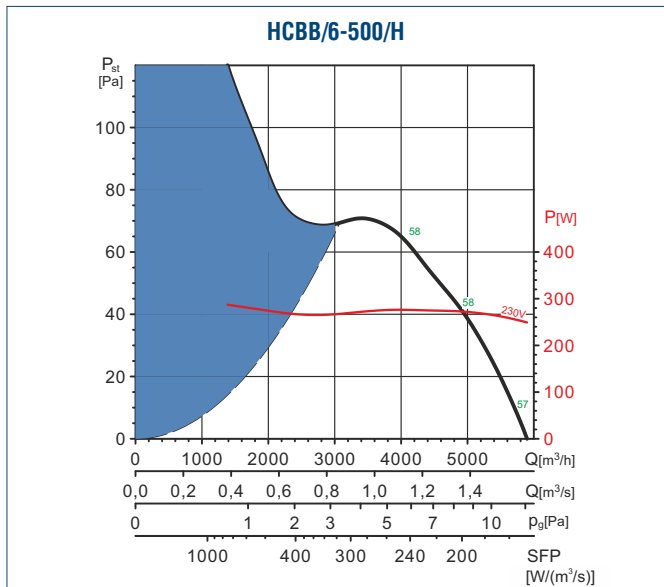
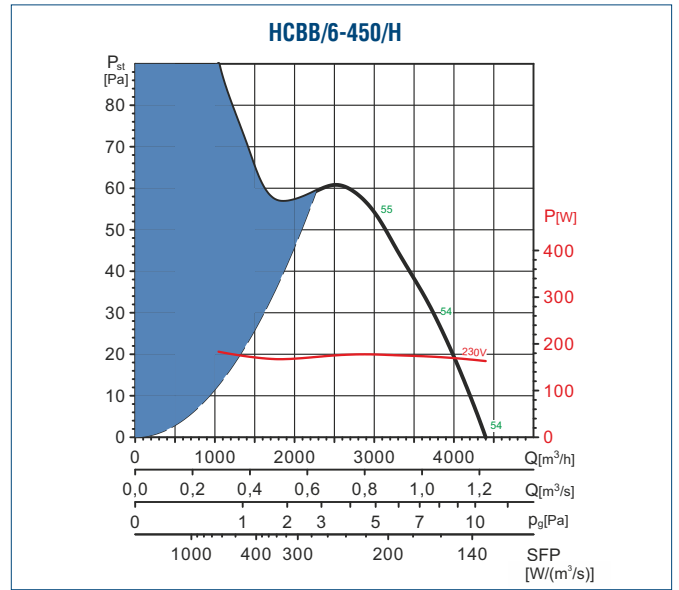
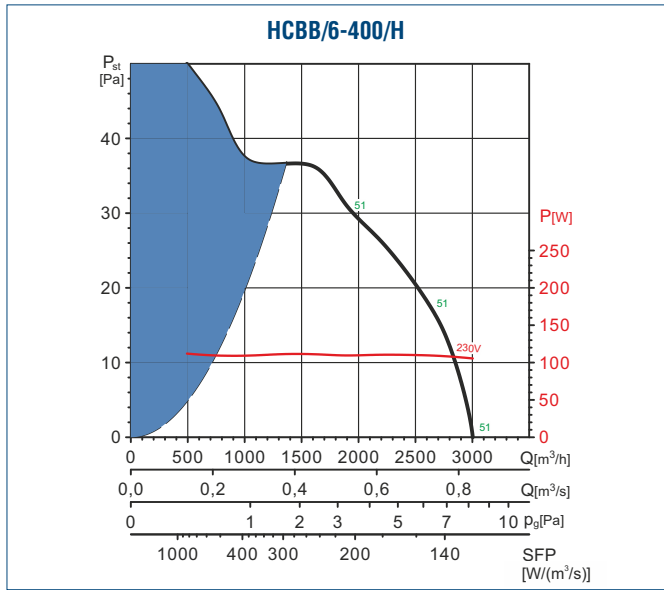

Charakterystyki pracy

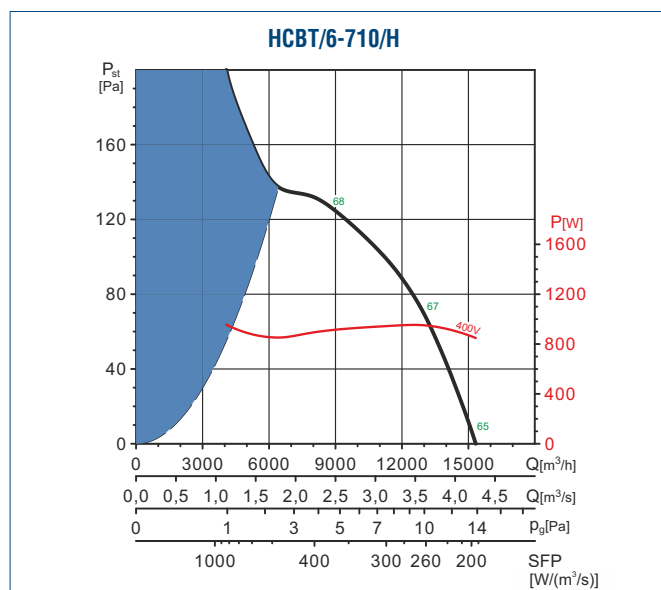
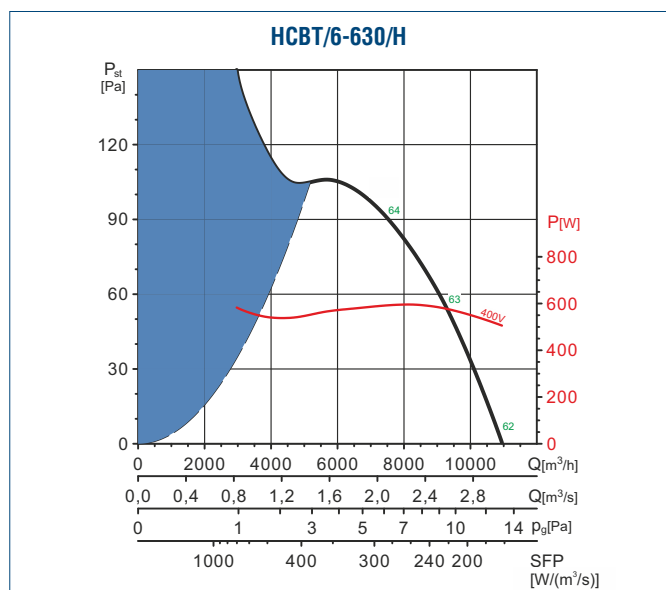
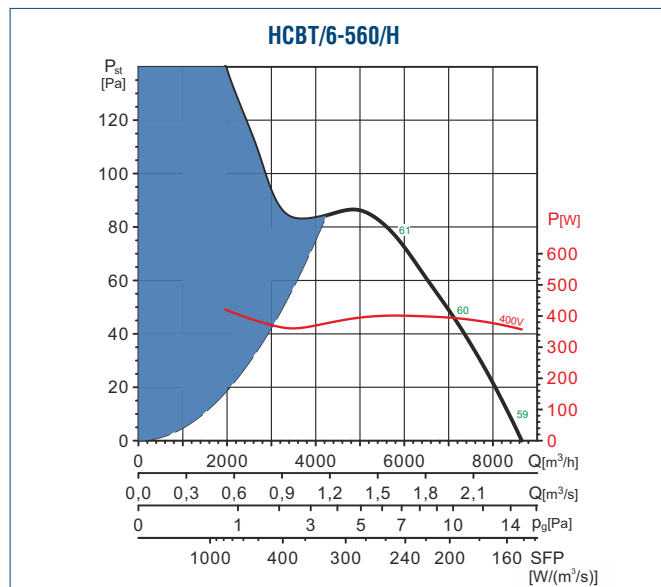
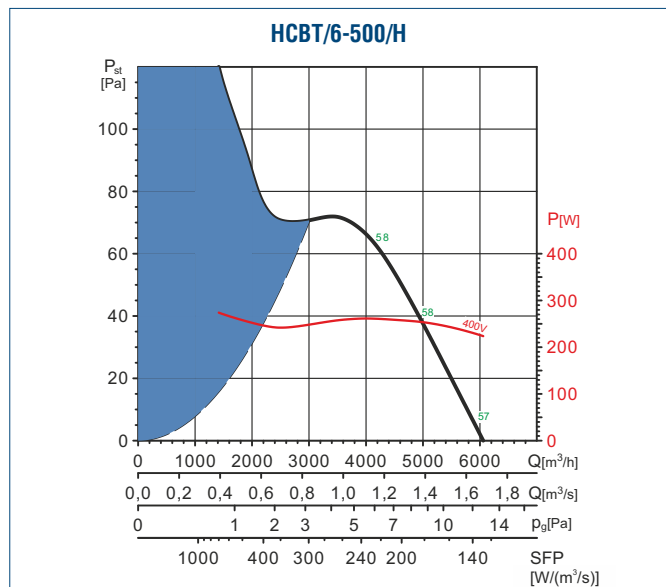
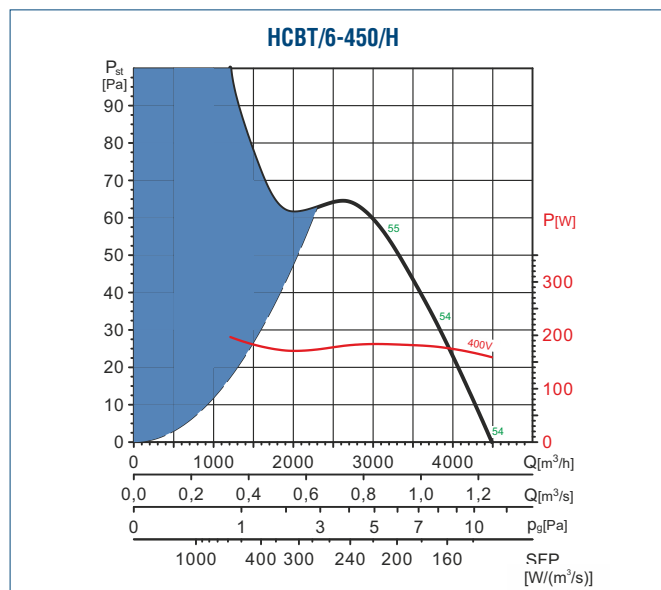
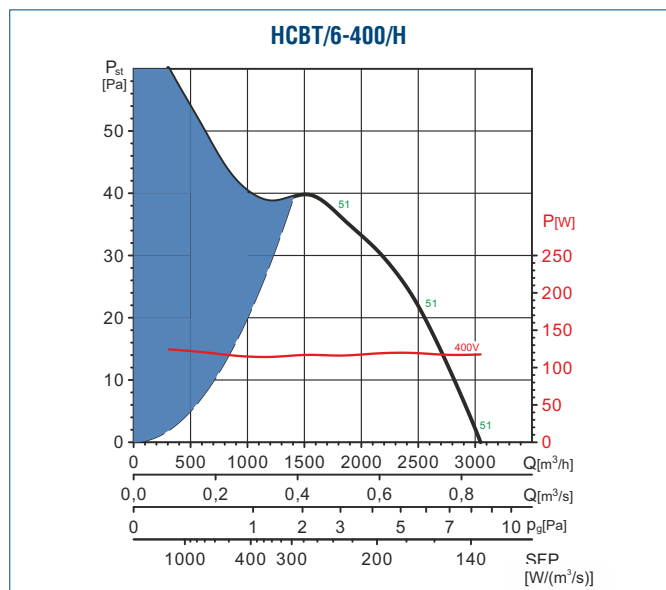

Charakterystyki pracy

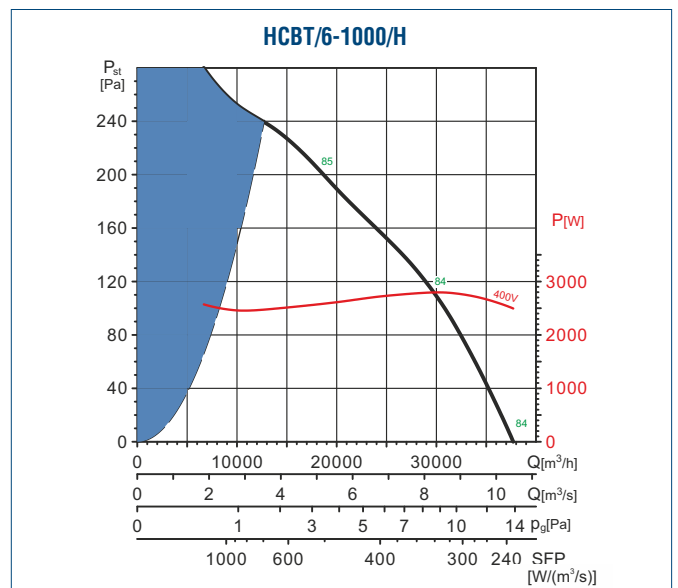
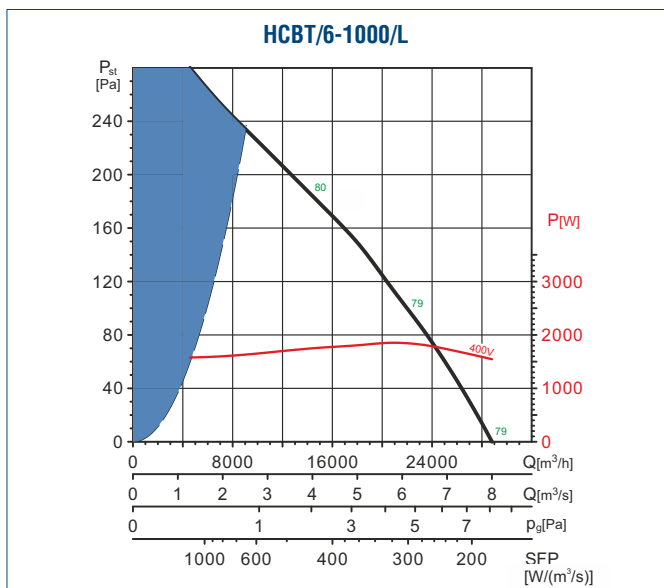
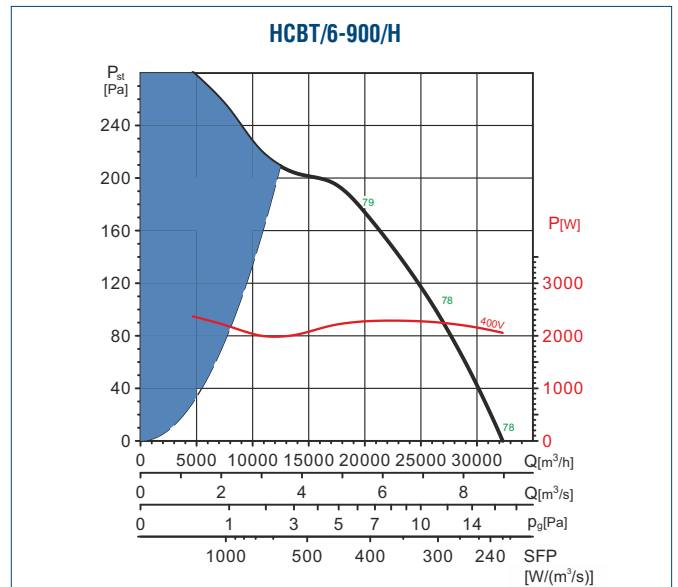
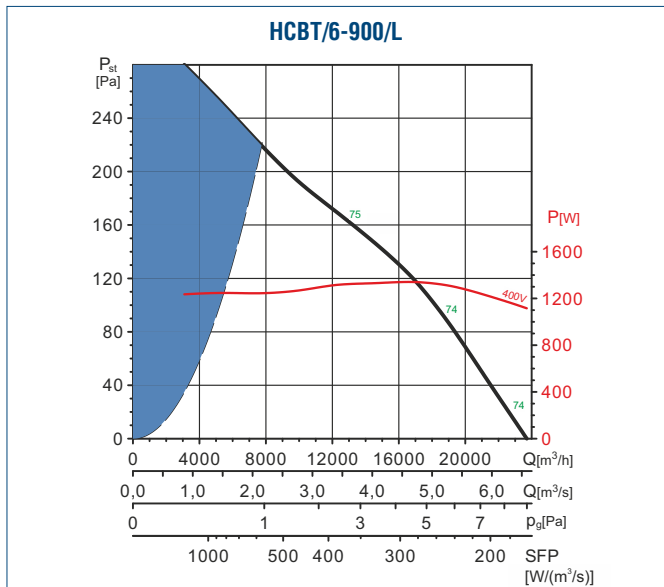
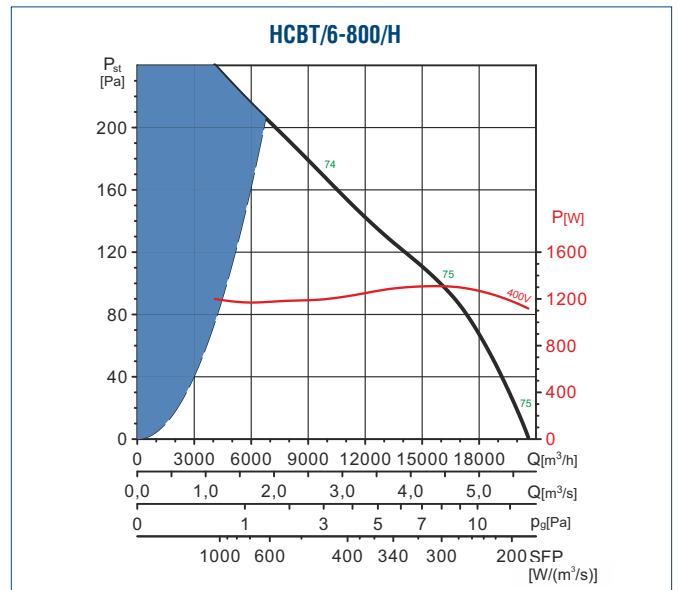
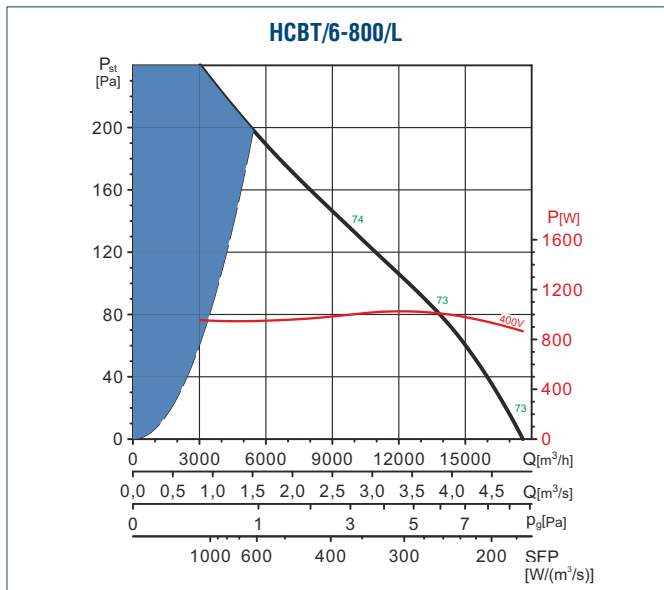

Charakterystyki pracy

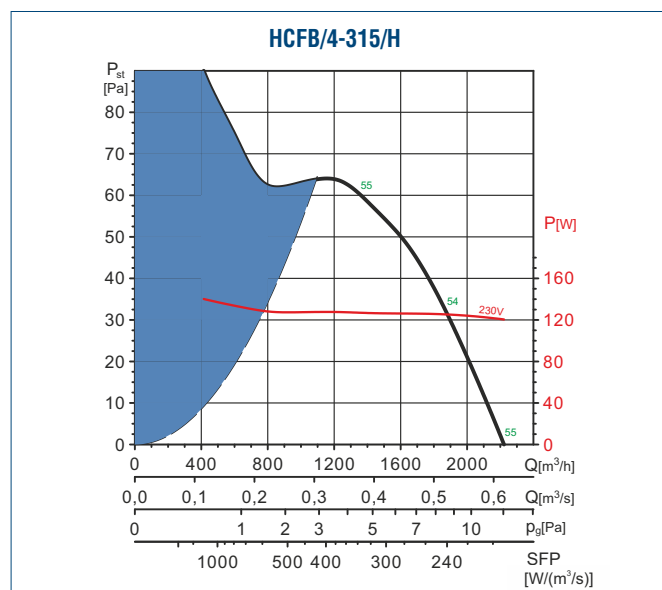
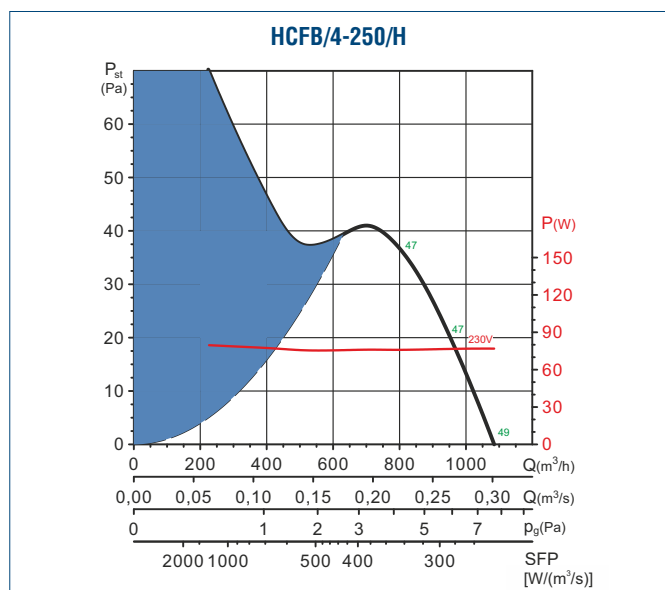
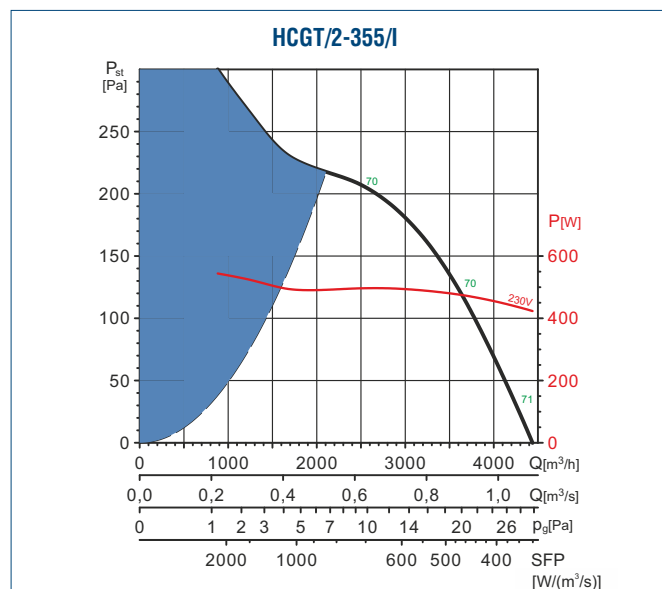
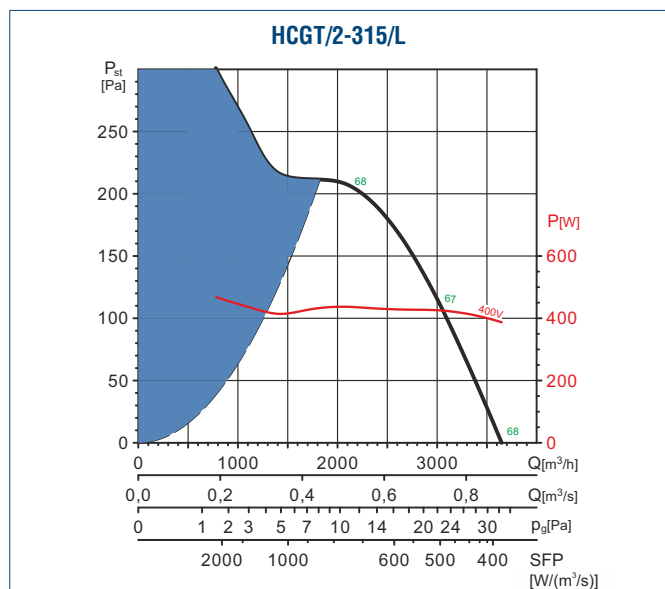
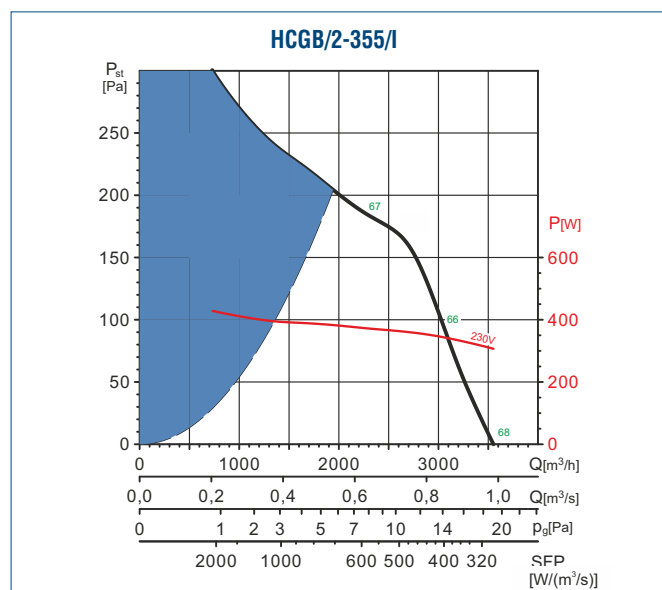
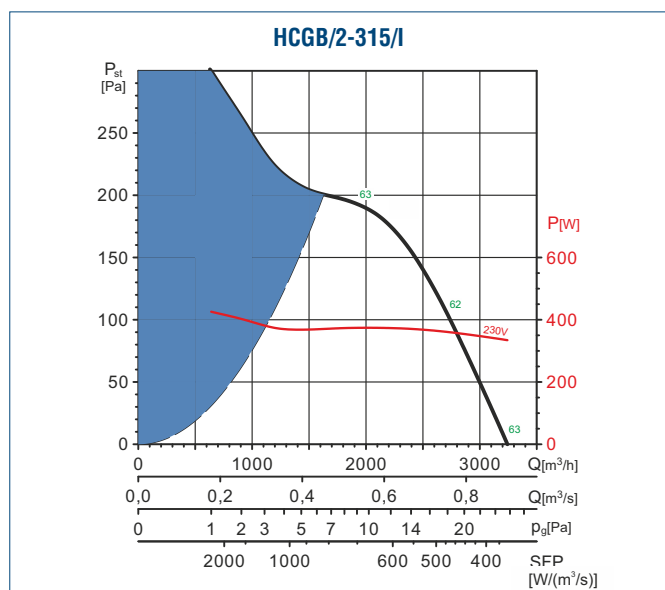

Charakterystyki pracy

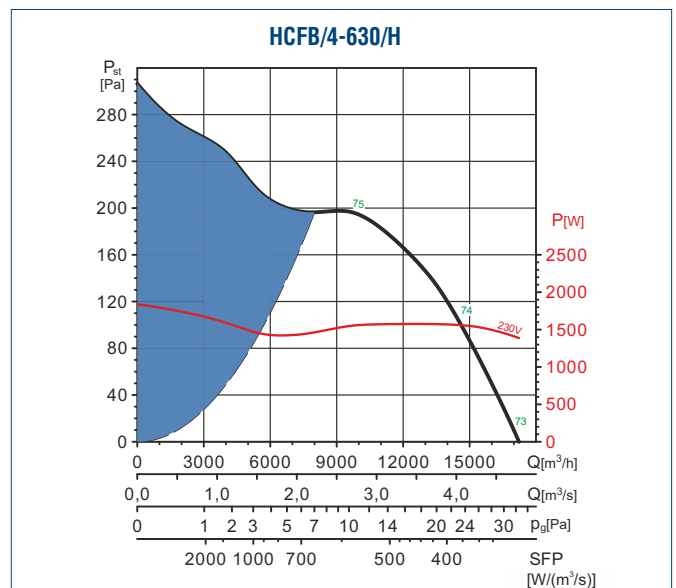
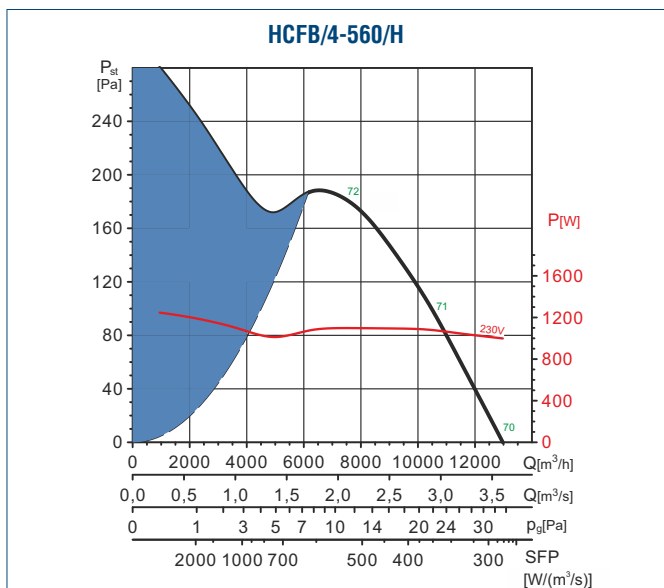
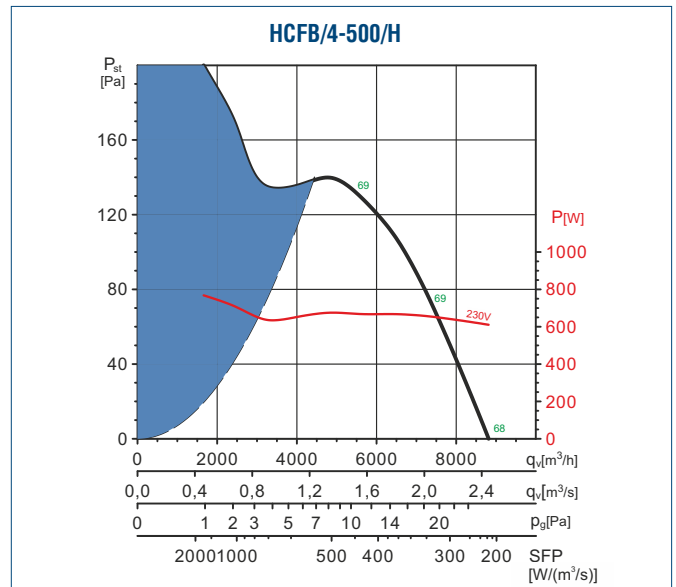
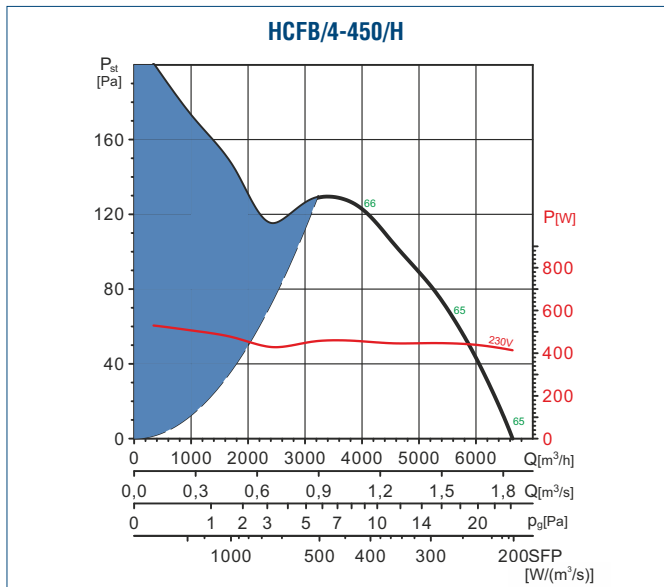
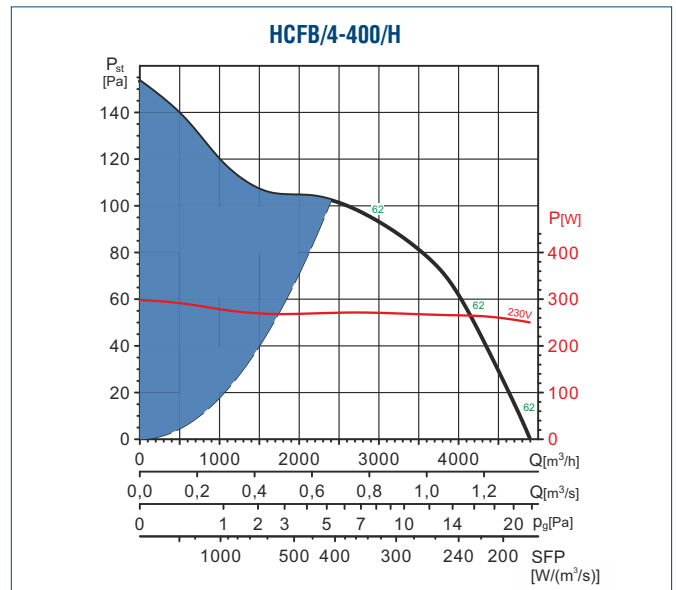
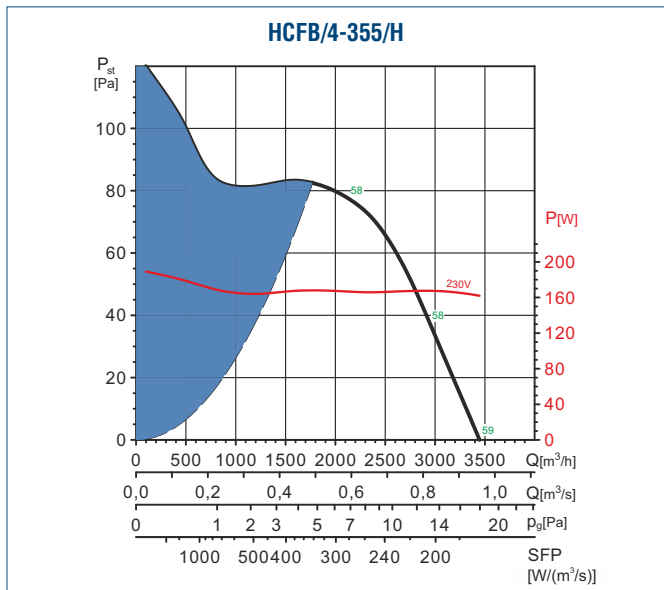

Charakterystyki pracy

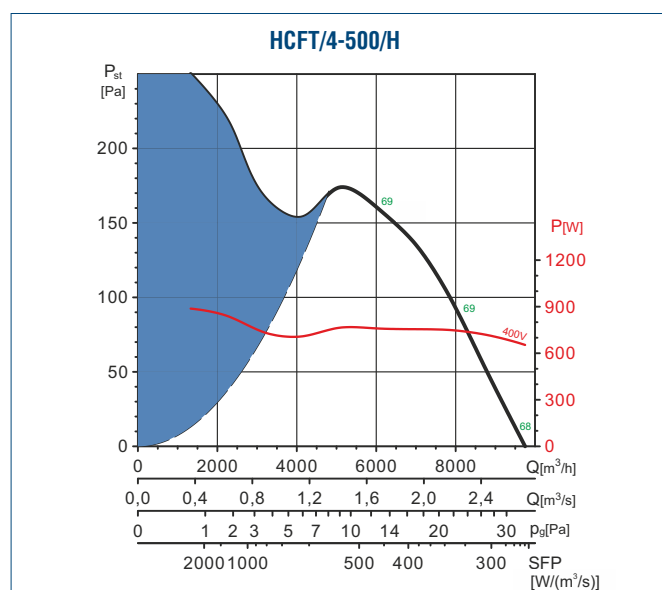
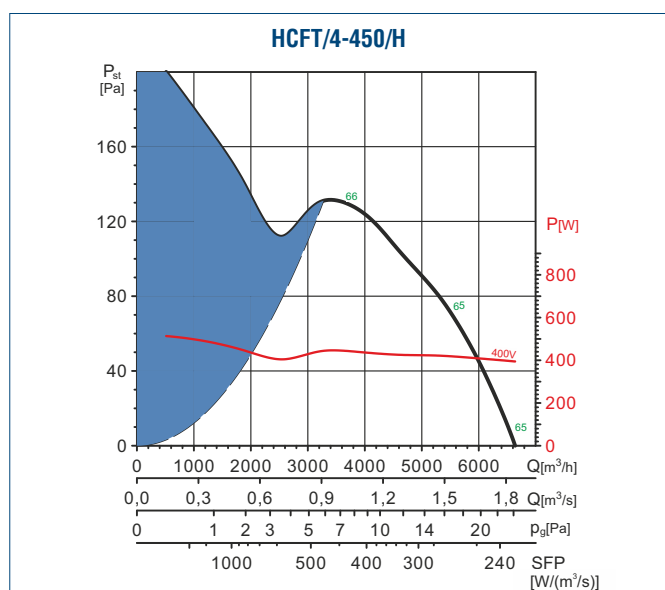
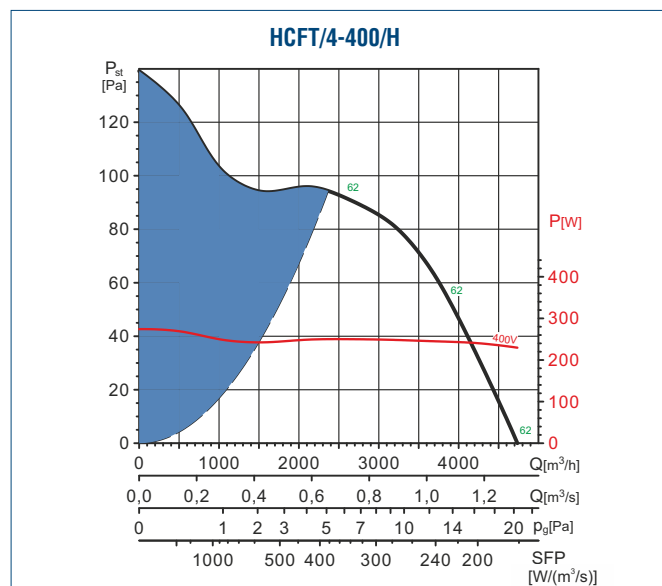
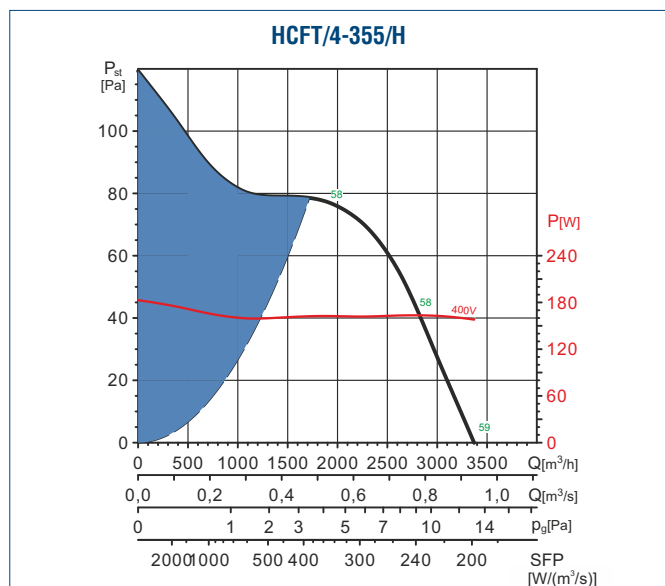
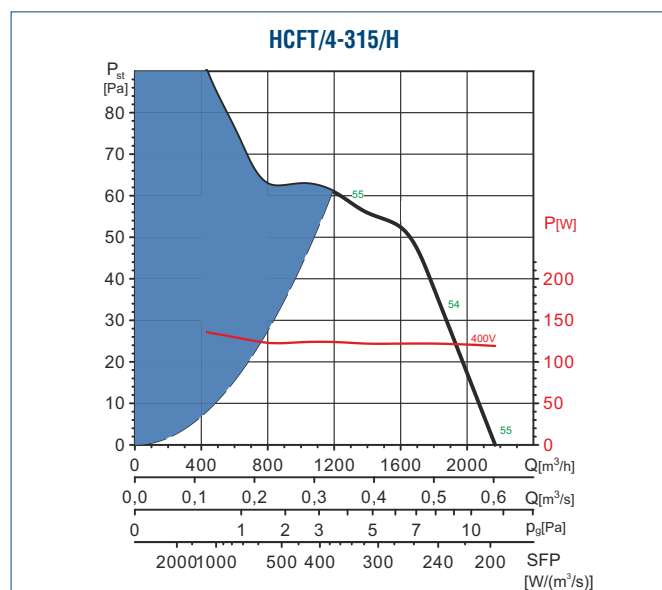
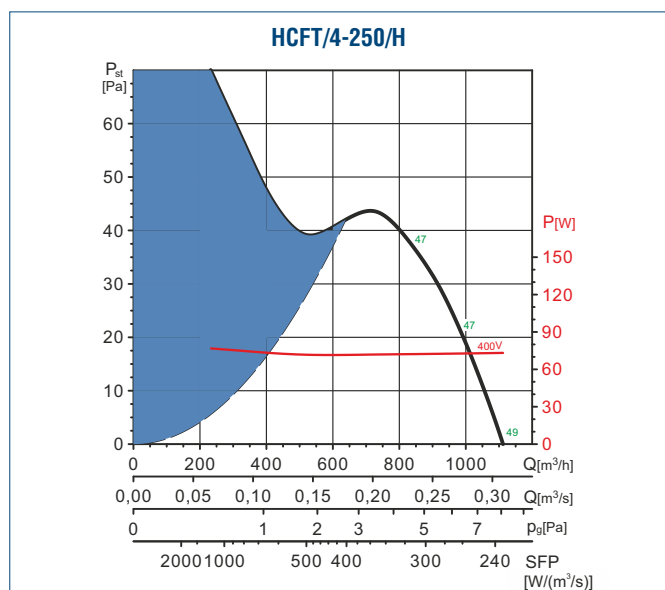

Charakterystyki pracy

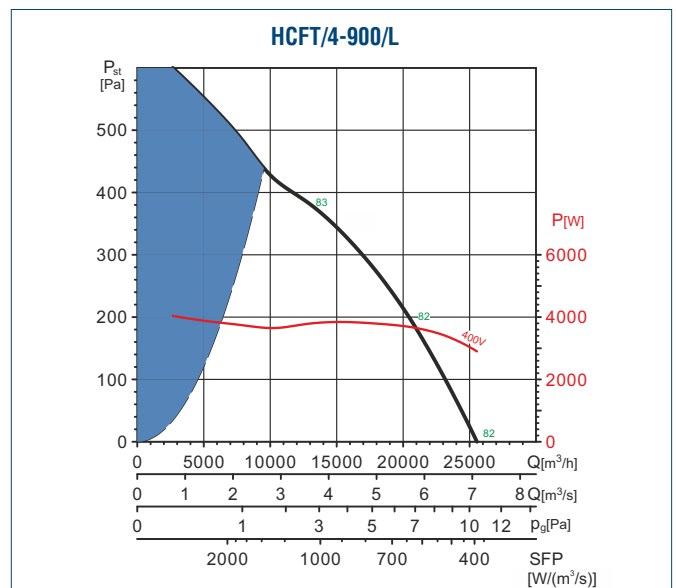
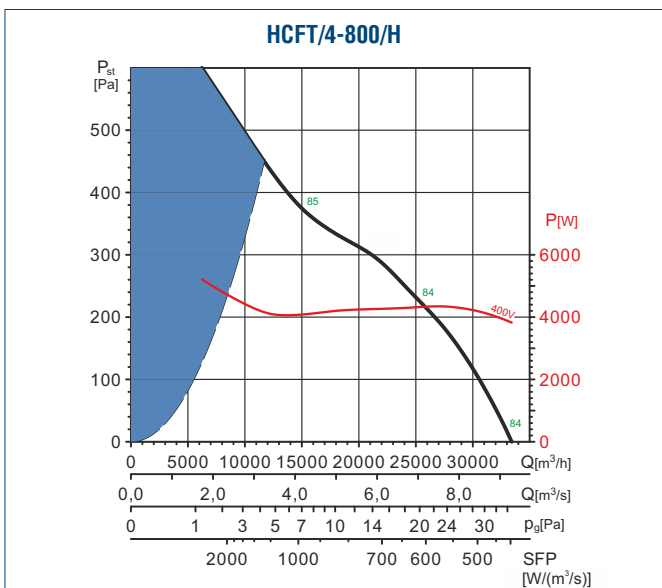
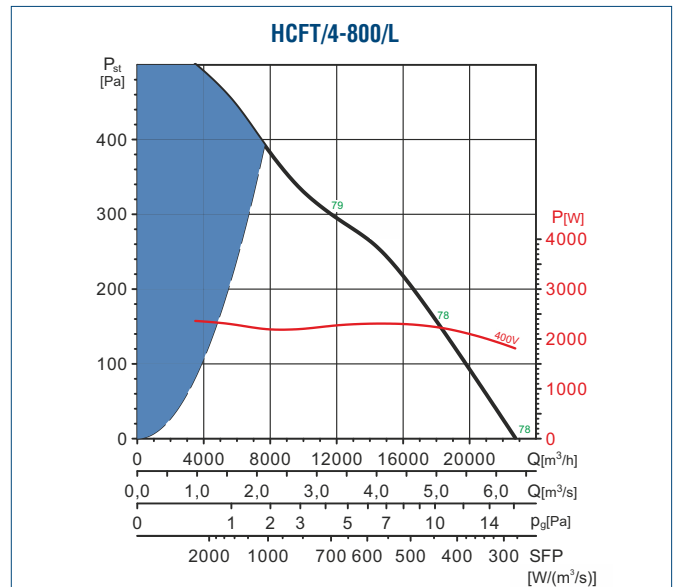
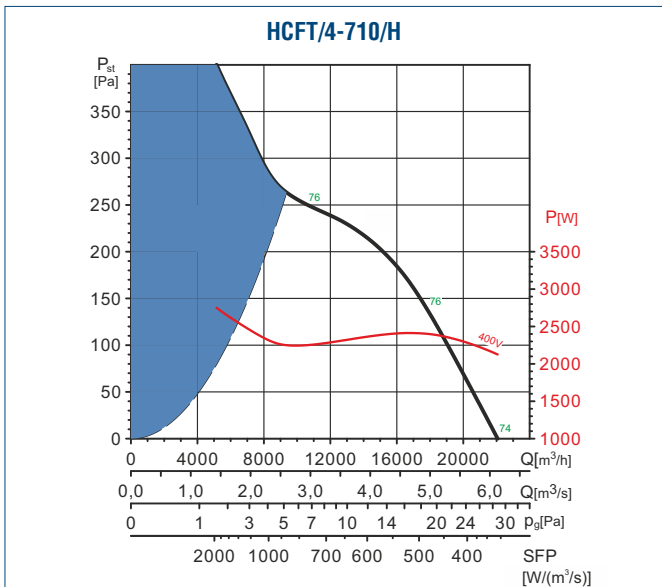
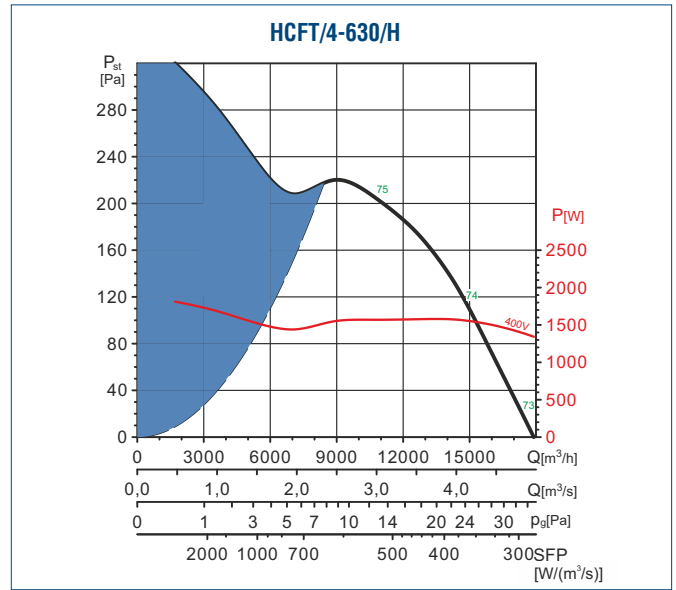
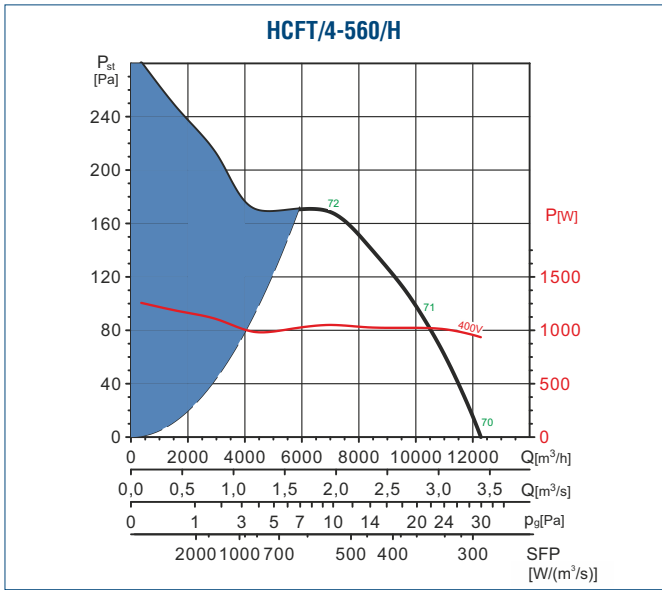

Charakterystyki pracy

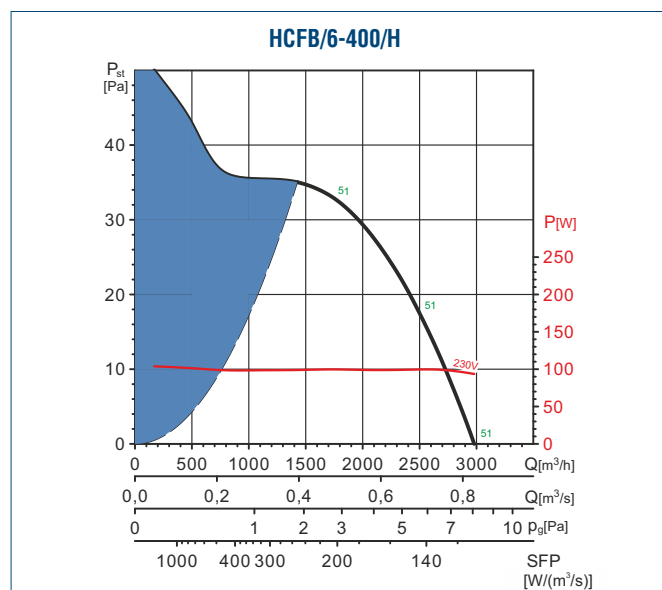
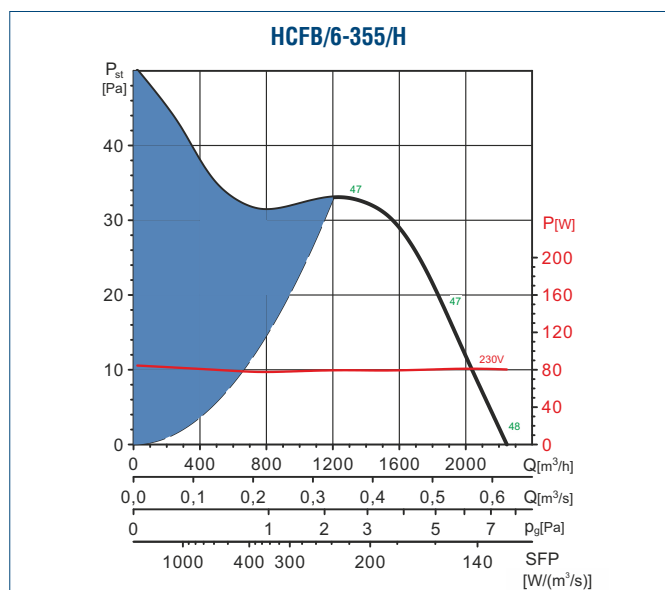
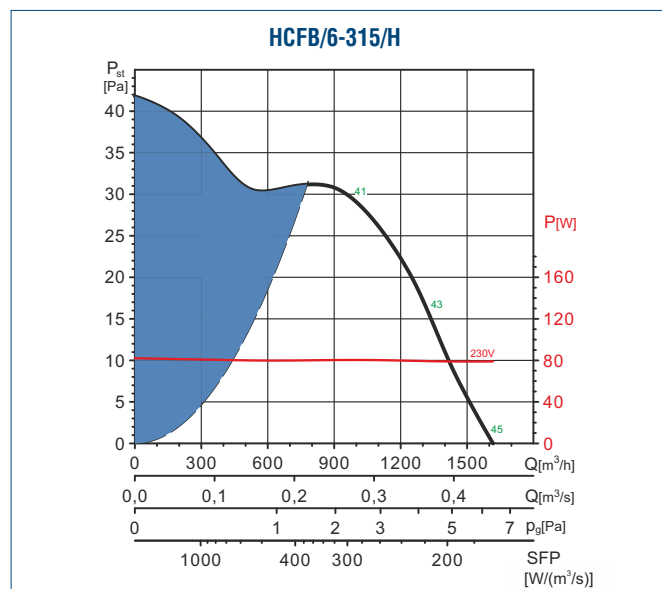
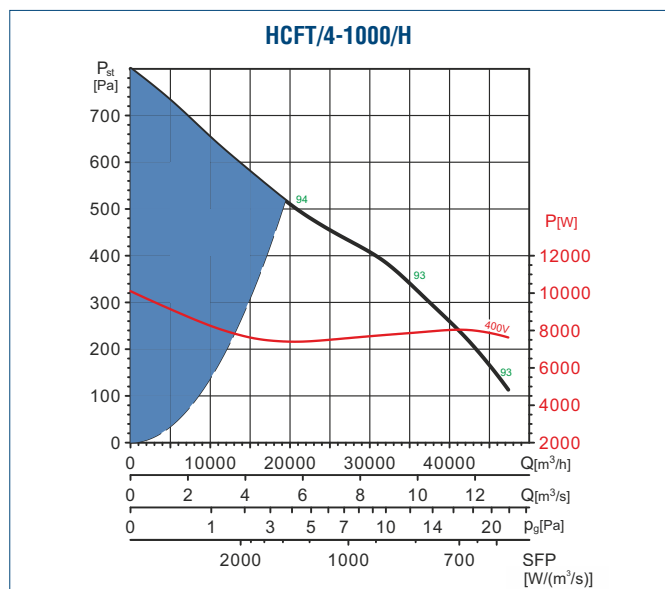
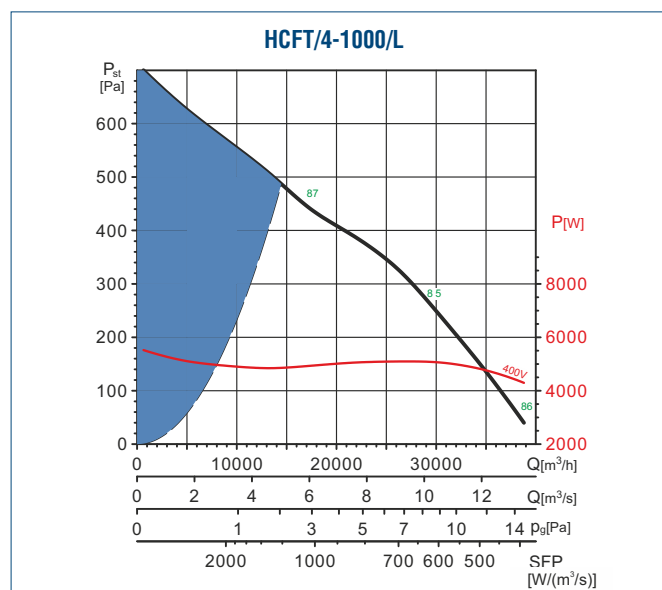
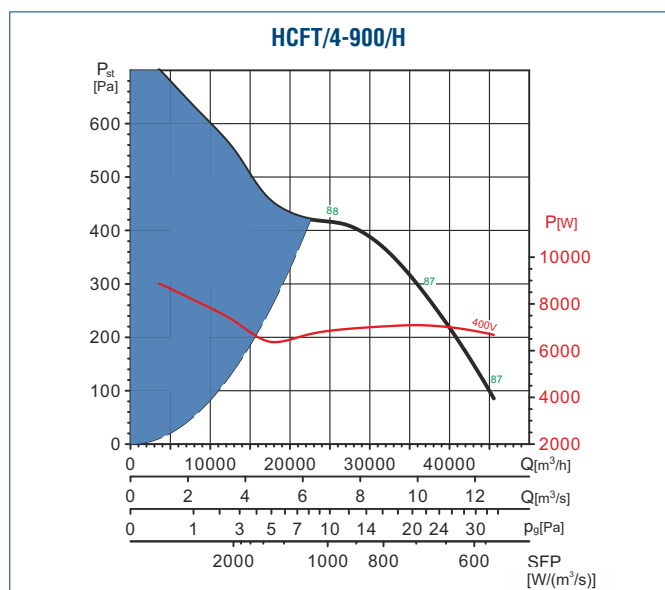

Charakterystyki pracy

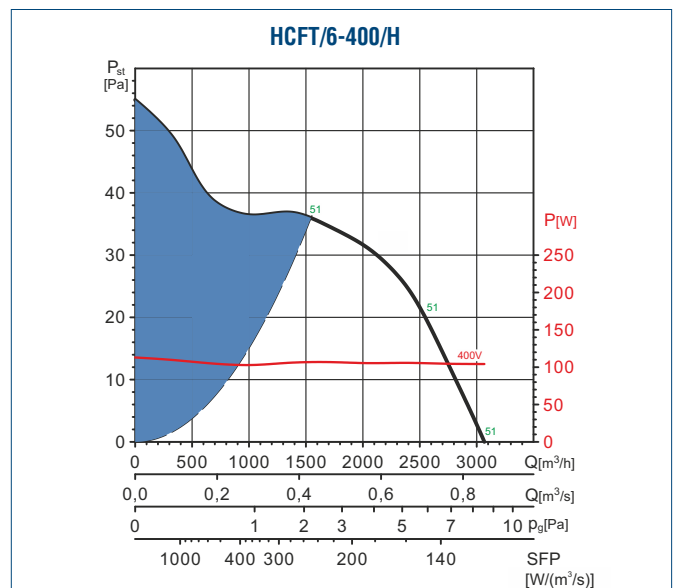
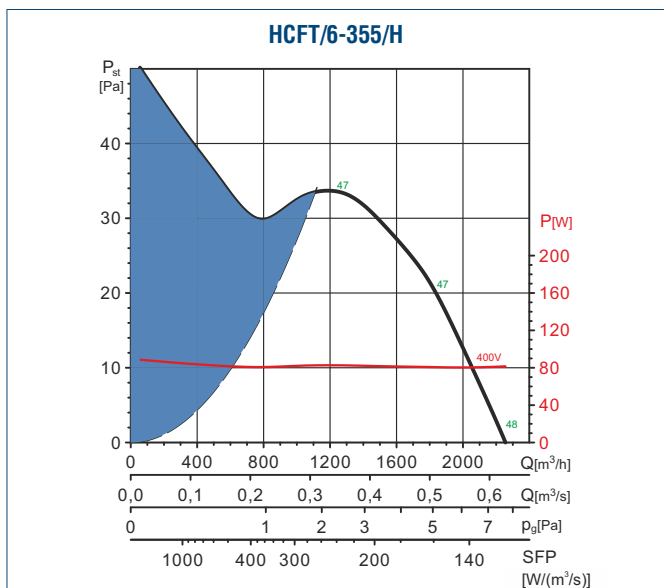
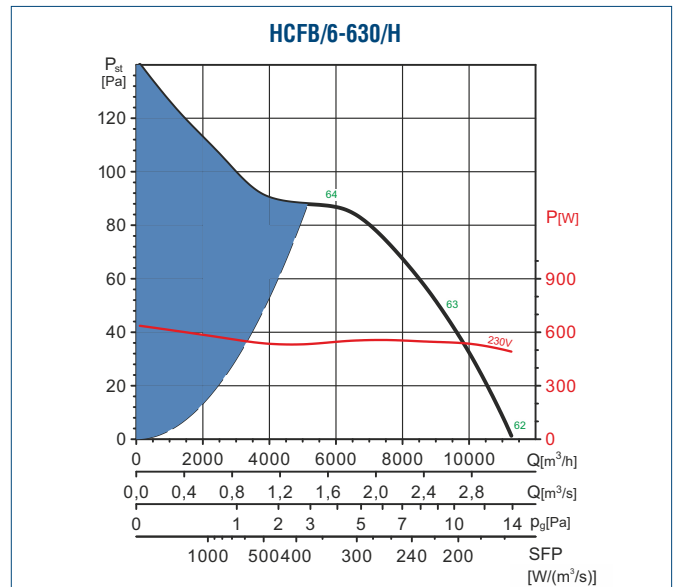
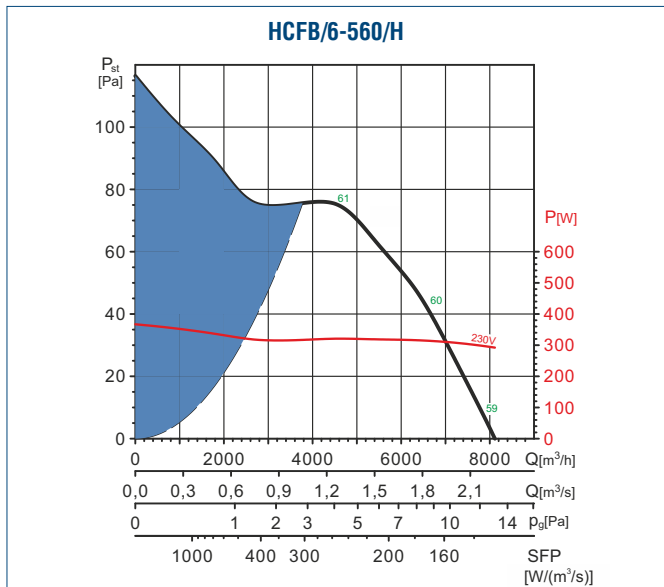
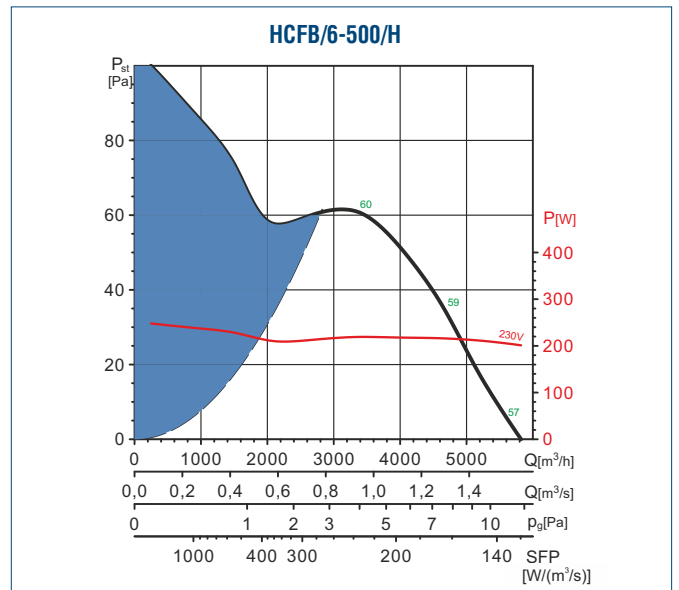
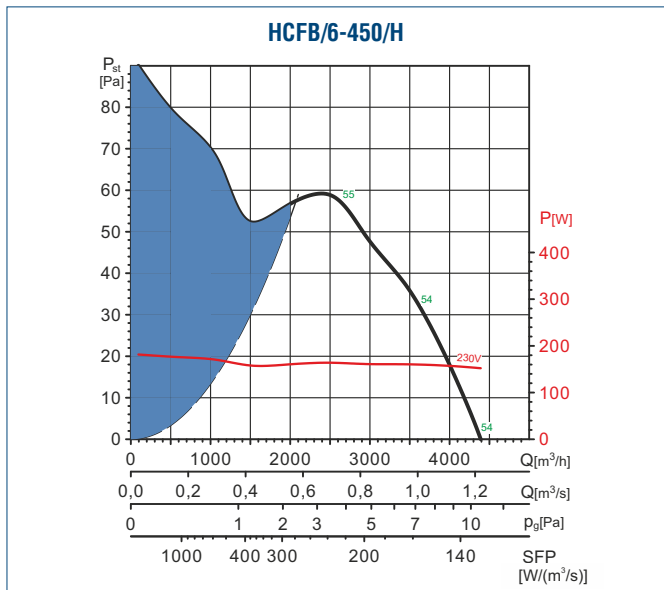

Charakterystyki pracy

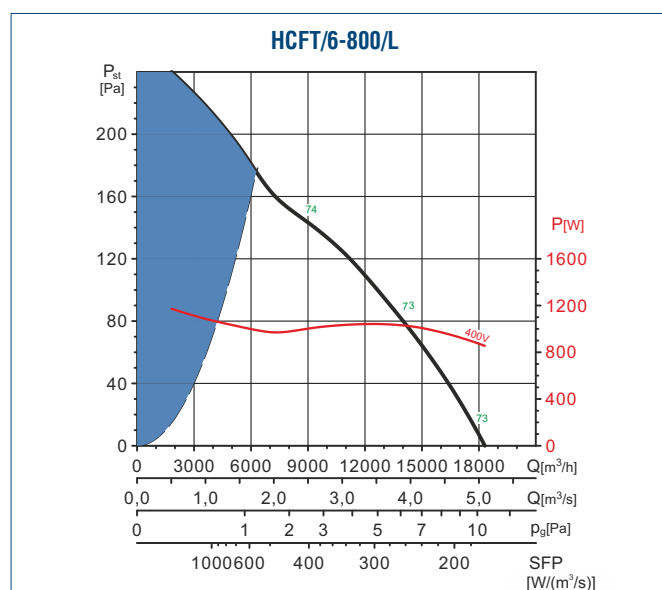
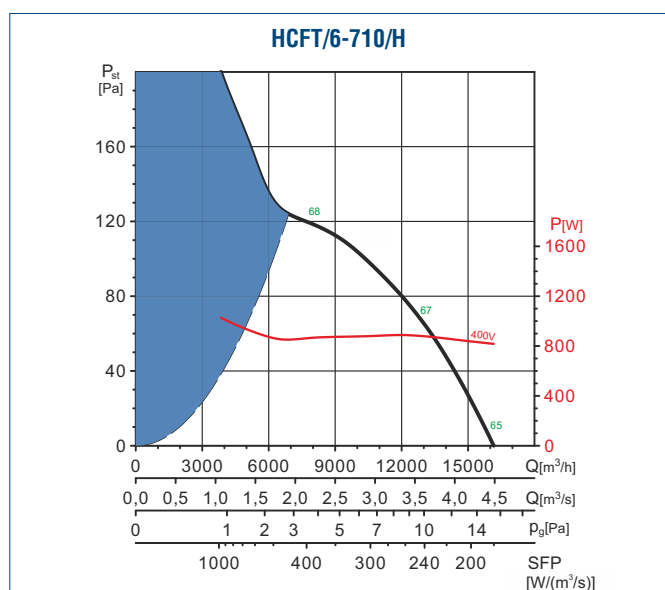
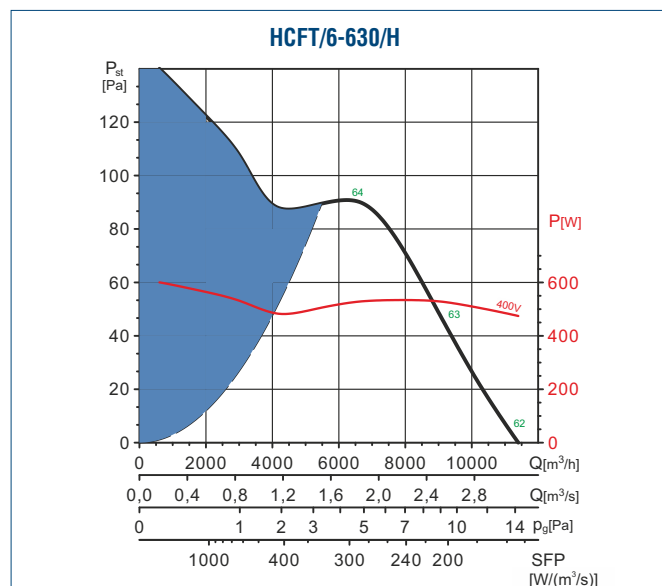
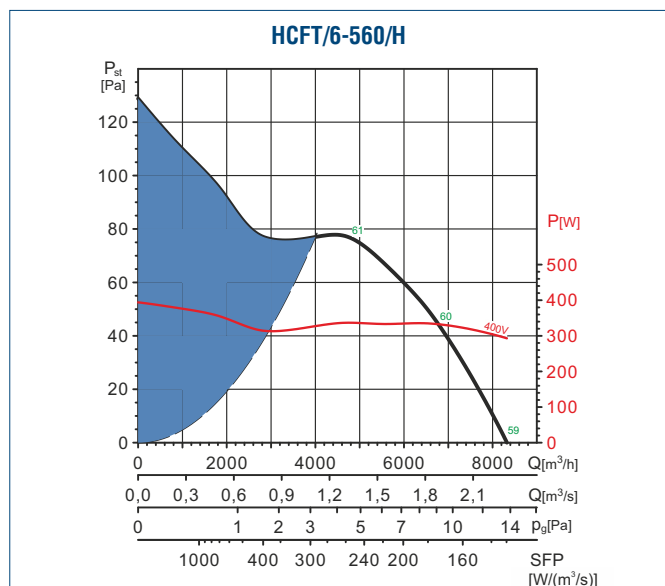
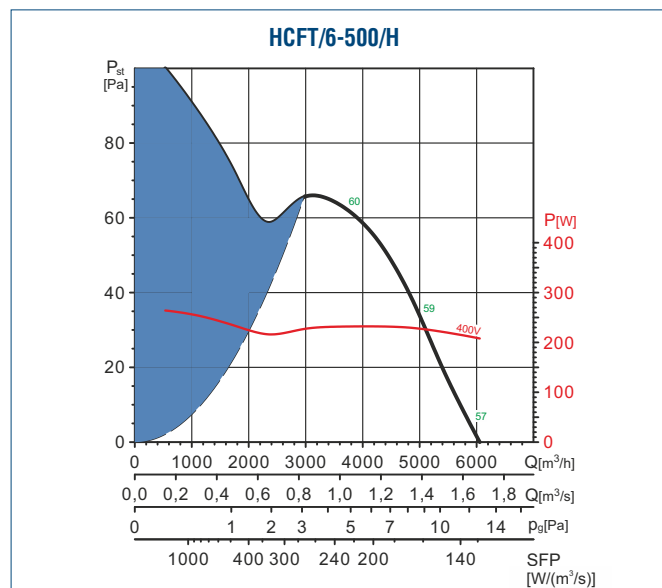
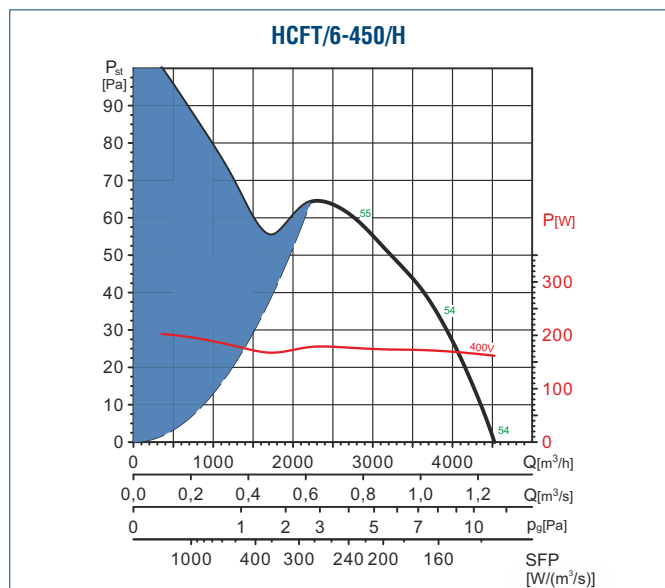

Charakterystyki pracy

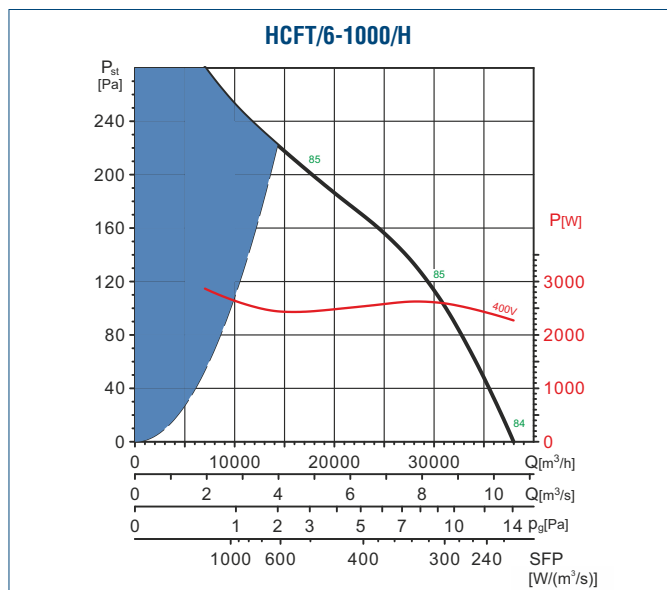
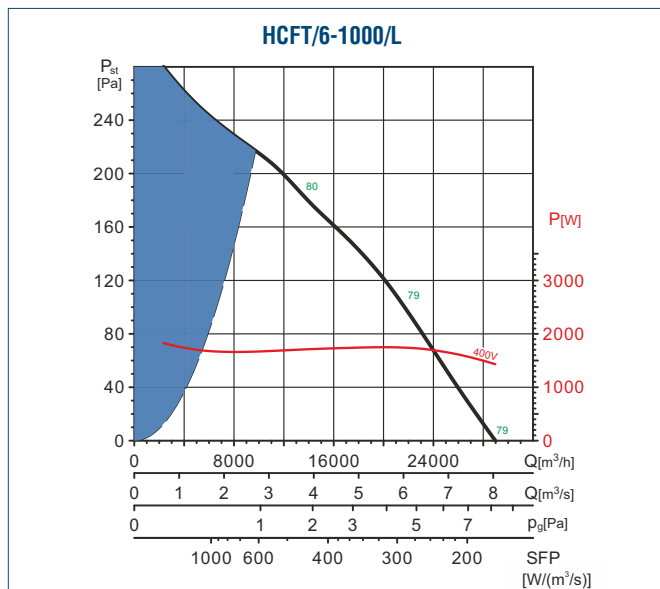
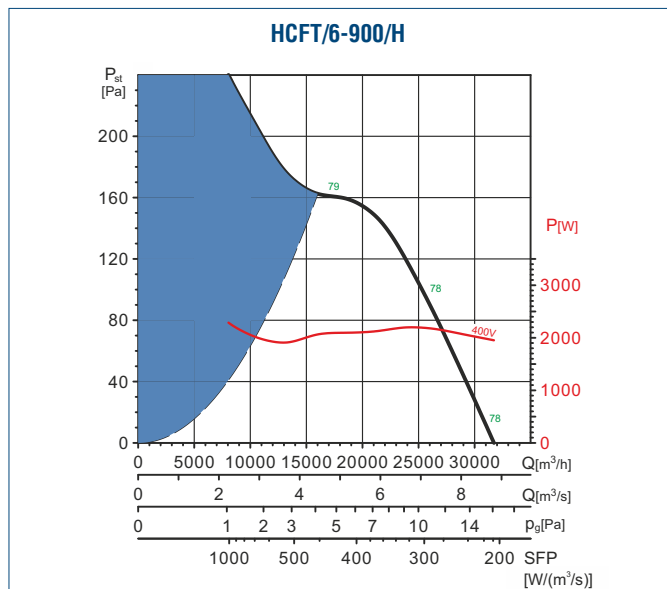
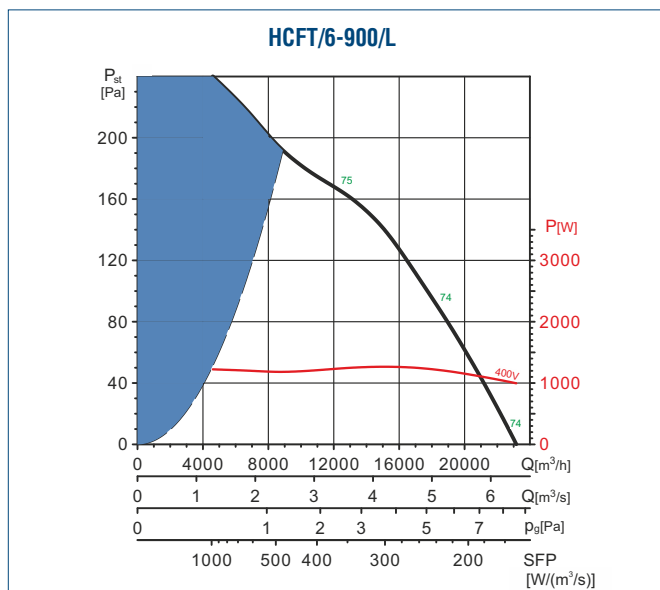
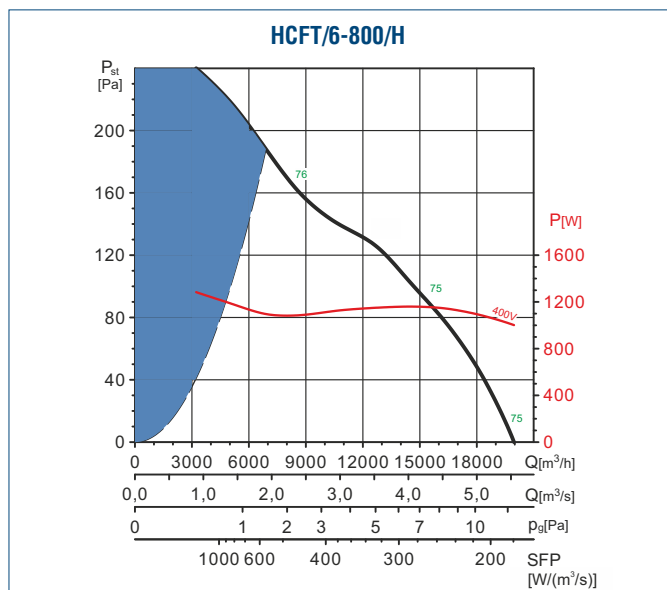

Montaż akcesoriów

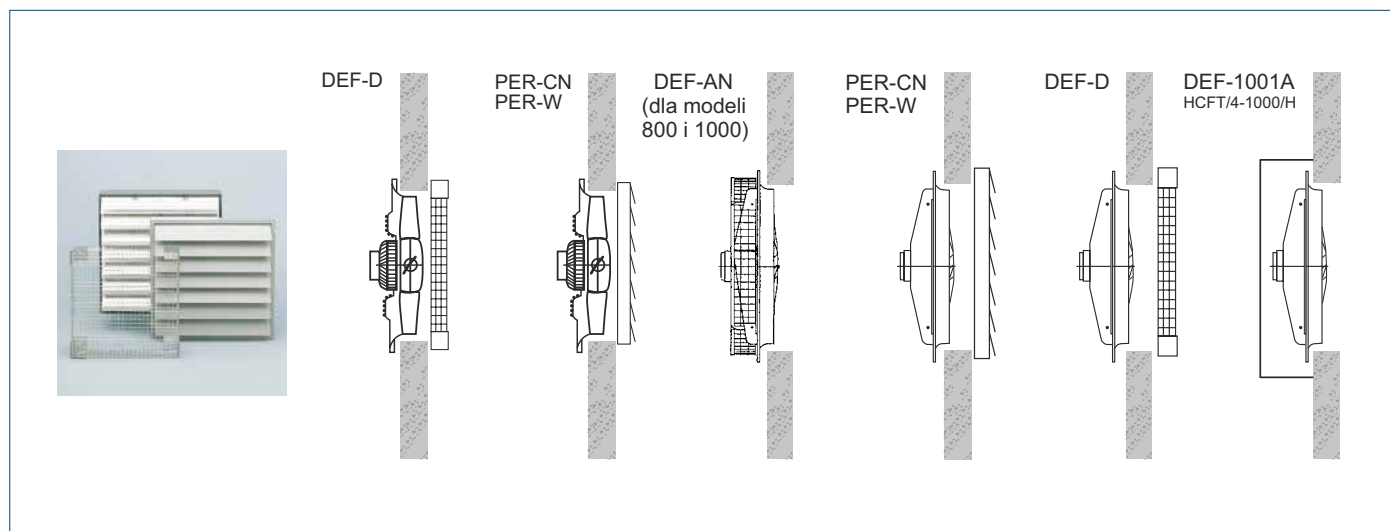

Model HCFB/HCFT HCBB/HCBT	Osłona wlotu		Żaluzja wywiewna		
	Wylot	Wlot	Tworzywo sztuczne	Aluminium	Wersje EX*
250	DEF-250 D	-	PER-250 W	PER-250 CN	PER-315 Ex
315	DEF-325 D	-	PER-355 W	PER-355 CN	PER-315 Ex
355	DEF-375 D	-	PER-355 W	PER-355 CN	PER-355 Ex
400	DEF-450 D	-	PER-400 W	PER-400 CN	PER-400 Ex
450	DEF-450 D	-	PER-450 W	PER-450 CN	PER-450 Ex
500	DEF-525 D	-	PER-500 W	PER-500 CN	PER-500 Ex
560	DEF-630 D	-	PER-560 W	PER-630 CN	PER-560 Ex
630	DEF-630 D	-	PER-630 W	PER-630 CN	PER-630 Ex
710	DEF-800 D	-	PER-710 W	PER-710 CN	PER-710 Ex
800	DEF-800 D	DEF-800 AN	PER-800 W	PER-800 CN	-
900	DEF-1000 D	DEF-900 AN	PER-1000 W	PER-1000 CN	-
1000	DEF-1000 D	DEF-1000 AN	PER-1000 W	PER-1000 CN	-
HCFT /4-1000 /H	DEF-1000 D	DEF-1001 AN	PER-1000 W	PER-1000 CN	-

* Do wentylatorów HCBT EX. Więcej informacji w akcesoriach montażowych.